

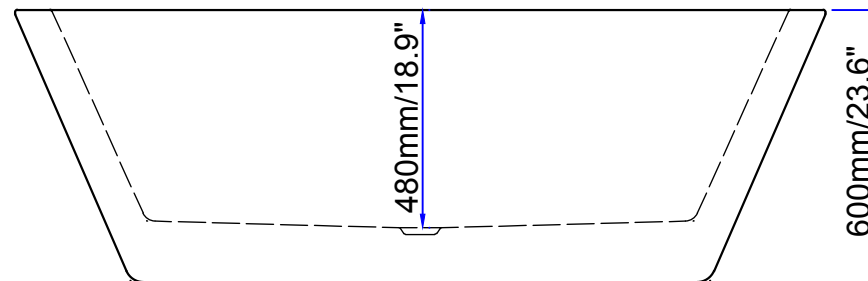

Streamline

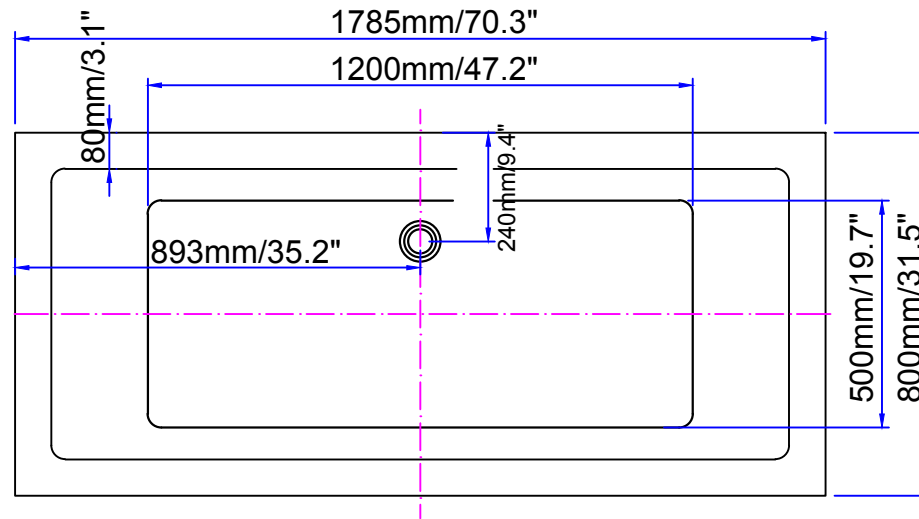

N-321-70FSWH-FM