

Attention

1. Turn on the power and make sure it won't surpass the electric current.
2. Make sure to fix leakage protection device, and the socket must be connected with earth line.
3. Please don't block the water recycle net by any part of your body, if that occurs, turn off the pump or power at once.
4. A switch for the supply of the hot/cool water must be installed, when stop to use this product. The water supply switch and the power source switch should be turned off.
5. Check the water level if it is 10-20 mm above the spray nozzle before you start the pump or the pump could be damaged.
6. Dispose of this product according to the local law when it is out of use.
7. Please contact the local dealer for help if you have any problem.

Circuit diagram

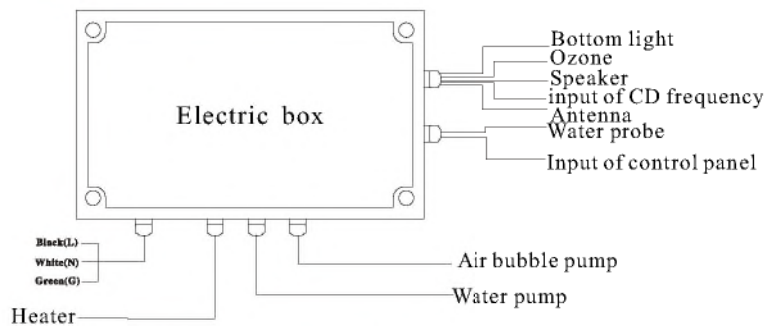

The related connection will not be connected if the unit without bubble system, heat pump, bottom light installed.



Do not dispose this product as unsorted municipal waste. Collection of such waste separately for special treatment is necessary.

∴kitchensource.com

INSTALLATION INSTRUCTION

MASSAGE BATHTUB

MODEL : WS-150150



Your best choice!

Dear user:

Thank you very much for purchasing our sanitary ware. To enable you to use this product safely and effectively, please read this installation and operation manual carefully before use.

Cautions

1. Please ensure that the product installed reliable electric leakage protection device, the power plug contains earth line, and make sure it is reliable earthing. Check the protect system of leakage protection each time before use.
2. Before turn on water pump, check if the water level over jets 10 to 20 mm or not, make sure regular usage of water pump otherwise it will be destroy because of water leakage.
3. Do not turn on water pump, heat pump or air bubble pump without water.
4. People with Hypertension symptom, after drink or heart disease are not allowed to use the bathtub. Children have a bath must under adult's guidance.
5. During use please noticed that don't blocked the jets and avoiding the air adjustment valve overflowing. Also keep the bathtub clean and don't let it blocked by hair or mess.
6. During use, please firstly adjust the water temperature or it will be burned.
7. The outdoor spa is designed with ergonomic, rise and fall changes are quite big so during use pay more attention of being slipped.
8. Please shut down the system when not to use.

Technical parameter

1. Voltage: 220V 60Hz
 2. Hydraulic pressure : 0.1~0.2Mpa
Storage capacity:0.36m³ Storage capacity:79gallon
 3. Power of the water pump :750W
 4. Power of the air pump :200W
 5. Power of the heat pump :1500W
 6. Size: 1520×1520×690mm
- (Remark:Auto heat system, air bubble pump and the bottom water light are the options for the goods.)

Cleaning and Maintenance

1. The daily maintenance should be cleaned with ordinary detergent and soft cloth. Please do not use the detergent which contains acetone or ammonia liquid. If there marks or something like glue on the surface of bathtub, just polish it with soft cloth dipping with gas.
2. If there are scratches on bathtub surface, please polish it with 1500# frosted paper dipping with liquid and burnish it with toothpaste. It will be shining again after that.
3. If there are furring on the surface of bathtub, it can be take away by mild acid detergent, for example wipe the bathtub with lemon juice or vinegar which be heated.
4. Do not wipe the chrome plated spare parts all the time, and do not get in touch with chemical detergent etc. Otherwise the surface of chrome plated will be destroyed. The product should be clean by soft cloth other than coarse cloth.
5. To check the water pipe regularly in order to avoid troubles from crack of water pipes or blocked inside.
6. If there are something such as hair stuck inside the jets, then just to twist out the jets and remove it.
7. To clean hydro-massage equipment: To full fill hot water which is 40°C, and pour 2g/L detergent, start hydro-massage function more than 5 minutes, then turn off the massage function and drain out the water. Next, to full fill cold water and start hydro-massage function for 3 minutes, then turn off the massage function and drain out the water, at last, to dry the bathtub with towel.
8. Filter should be clean once a week.
9. Keep out from combustibles and goods which over 80° C to avoid fire disaster and damage the product.
10. The bathtub should be transported carefully. Do not lay heavy things on it and do not bump and shaking the tub. If the bathtub has not been used for a long time, drain out the water of the bathtub and keep it in a dry and ventilate environment. Avoid corrosive gas.

Troubleshooting

Problems	Reasons	Maintenances
No power or electricity leaking protection device is activated	<ol style="list-style-type: none"> 1. Electricity leaking protection device cutoff power source when electricity line is not well connected. 2. Power or electricity circuit have phenomenon of electricity leaking. 	<ol style="list-style-type: none"> 1. check and reconnect the wiring system. 2. check the power source, electricity circuit and ground line.
Water Jets are not working.	<ol style="list-style-type: none"> 1. check the system whether is on. 2. the impeller of water pump doesn't rotate 3. water pump is broken which caused by working without water coming in. 	<ol style="list-style-type: none"> 1. turn on the system 2. check through and remove the garbage which is inside the pump. Switch pipe can be removed. 3. install a new water pump
The intensity of hydro-massage cannot be adjusted	<ol style="list-style-type: none"> 1. water pump's suction has not enough power. 2. air adjustment valve is abnormal 3. jets or nozzles are blocked 	<ol style="list-style-type: none"> 1. check the water pump whether is working normally. 2. change the air adjustment valve 3. remove things which are blocking the jets
Water leaks from the pipes.	<ol style="list-style-type: none"> 1. seal ring is broken 2. screws doesn't lock tightly 3. pipes doesn't seal properly. 4. water pipe is broken 	<ol style="list-style-type: none"> 1. change seal ring 2. lock the screws tightly 3. re-seal the silicone. 4. change water pipe
Control panel doesn't work	<ol style="list-style-type: none"> 1. Electricity line didn't connect to power source, electricity leaking protection device cut off power. 2. power button is not working. 	<ol style="list-style-type: none"> 1. Re-connect the power source and check the electricity leaking switch button. 2. change a new control panel <p>Lighting is off</p>
Jets shower can not be work	<ol style="list-style-type: none"> 1. voltage is abnormal 2. Switch cannot be work 3. control panel cannot be work 4. water in electromagnetism valve is blocked 	<ol style="list-style-type: none"> 1. please use it at the normal situation of voltage 2. check and change the switch 3. maintain and change the control panel 4. get rid of mess of the jets
No lighting	<ol style="list-style-type: none"> 1. The bulb is broken 2. power line is disconnected. 3. control panel is broken 	<ol style="list-style-type: none"> 1. change a new bulb. 2. re-connect the circuit. 3. maintain or change control panel
Radio is off	<ol style="list-style-type: none"> 1. speaker is broken 2. power line is disconnected. 3. control panel is broken 	<ol style="list-style-type: none"> 1. change a new speaker 2. reconnect the circuit. 3. maintain or change control panel

Manual

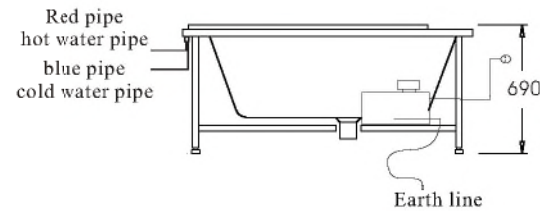
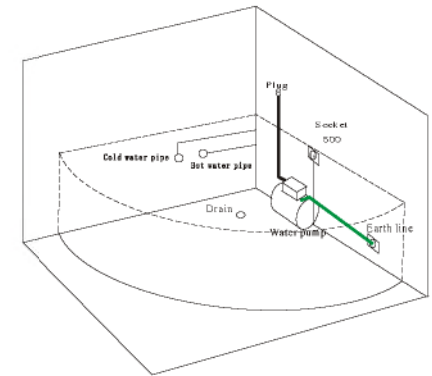
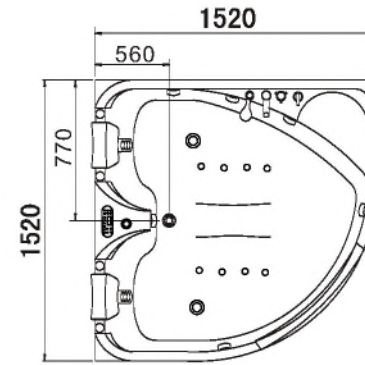

SIZE: 1520 x 1520 x 690mm

Sketch

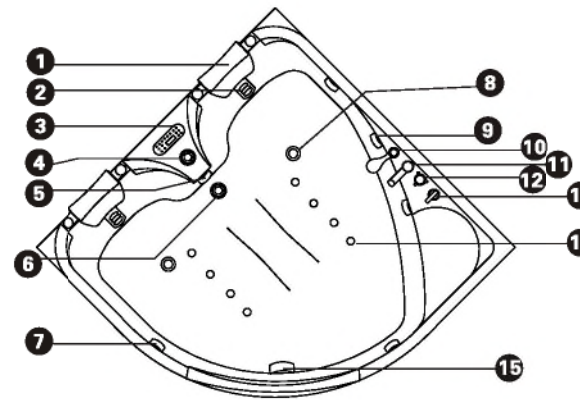

- 1, pillow
- 2, nozzle
- 3, control panel
- 4, air conditioning
- 5, drainage switch
- 6, drainage
- 7, water jet
- 8, water jet
- 9, water in
- 10, shower
- 11, tap
- 12, switch
- 13, cold/hot water switch
- 14, air bubble jet
- 15, bottom light

Manual





The related buttons has no effect if the unit without bubble system, heat pump, bottom light installed.

- 1 The remote control is waterproof and dampproof.
- 2 The usage of remote control and the function of control panel is basically the same.
- 3 Lay the remote control with care, and don't throw it.



Remote control is required by extra.



1. Start

Press “” button to start the system and LCD with display function. At the same time, all functions will standby. Repress “” button to shut down the system.



2. Fill water

Turn on the cold or hot water switch to fill water into the bathtub. Turn the cool or hot water switch to adjust the water filling speed and water temperature. Turn the shift switch to use shower head or faucet to fill water. Stop to fill water when the water level is 10-20mm above the massage nozzle.

3. Bottom light

Press “” to turn on the bottom lights, then the symbol will be shown on the screen. Press “” again to turn off the bottom lights.

4. Hydraulic massage

After system startup, water in bathtub exceeds the head level, then press  button to start water pump. and meanwhile, water pump symbol  shall be displayed on LCD. Repress  button to stop water pump function.

5. Bubble

Press “” to start the air bubble pump, then the symbol will be shown on the screen. The bubble jets spurt out air bubble. Press again to turn off the bubble.

6. Heater







Press “” to start the heater, then the symbol will be shown on the screen. The heater could keep temperature of water in the bathtub. Press it again to turn off the heater.

Remark: The massage bathtub has installed water probe. If it is waterless or the water lower than the top of probe, the air bubble pump, water pump and heater will not work.

7. Ozone

Press “” to start ozone disinfection, and press it again to turn off the function. This function should be used after bath.

8. Radio/CD

Press “” to open the radio, at the same time the symbol appears on the screen. Press “”, ” (between 87.5MHz to 108.0MHz) to search the channel, and press it again to search different channels. Press “” to turn down volume and press “” to turn up the volume. The volume will be shown on the screen, and the adjustable range is 0-40. Press “” again to turn off the radio and turn on the CD. At the same time, the symbol will appear on the screen. Press it again to turn off the radio and CD.

9. Power off

Press “” to stop all functions. Turn the drainage to let out the water, turn off the power source and the water supply.