

## Shower Drain Installation Cross-section Diagram

1. Determine the desired position of the shower drain. Locate the pipe through your flooring to desired position.
2. Pre-slope the floor to lead water to the outlet. It is suggested to create a 2% grade towards the shower drain. Linear drains usually require a single slope in one direction. However, if the linear drain is installed slightly off the wall, it will need to slope the adjacent area towards the drain.
3. Layer the pre-slope with a waterproof membrane, cut holes on the membrane for the screws and drain base. Waterproof test operated by qualified plumber is required for at least 24 hours after the membrane is fixed.

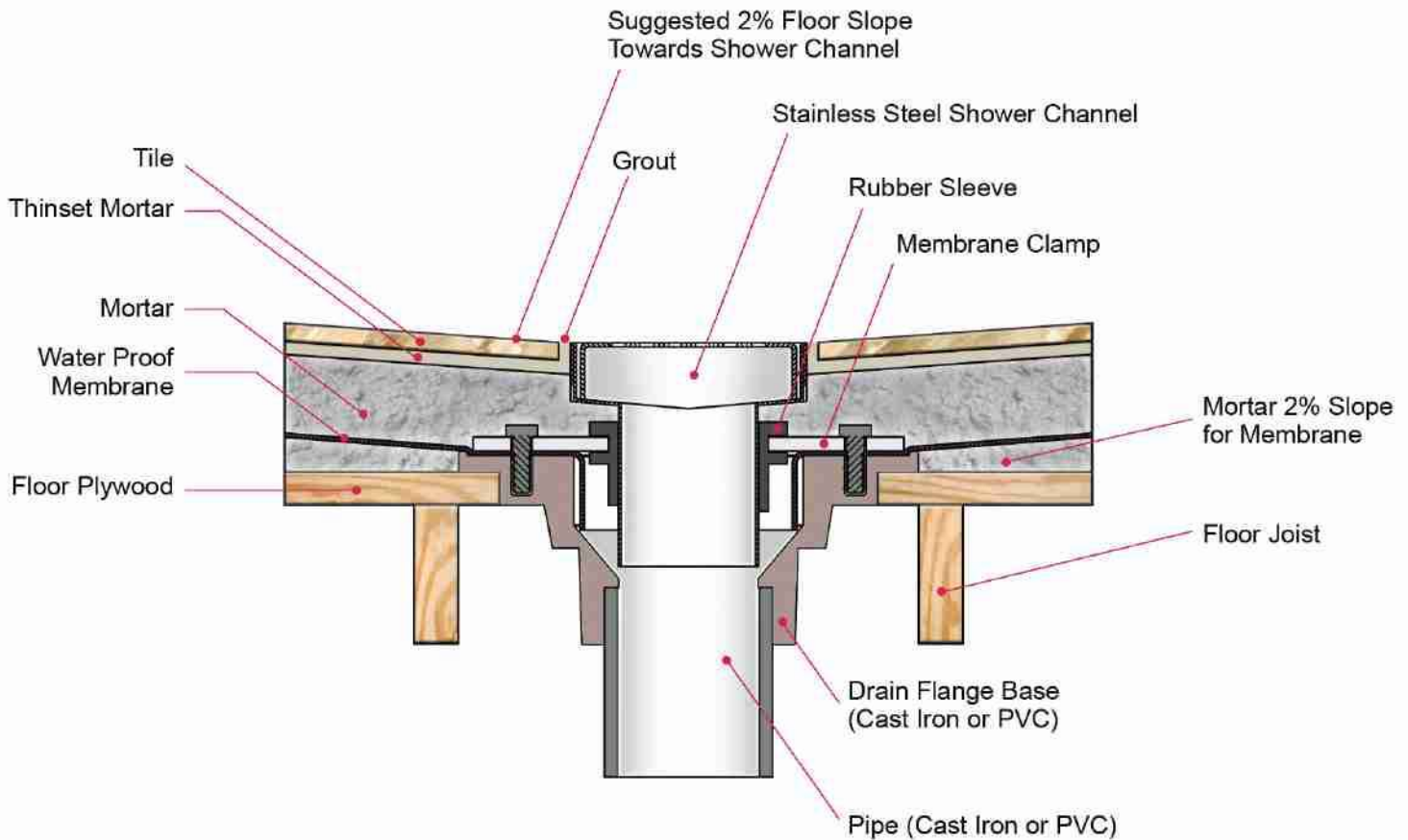

4. Assemble the drain grate to the drain channel. Assemble the clamping ring to the drain flange, and then install the gasket into the drain flange. Fasten the assembly with the screws.
5. Insert the drain channel into the gasket. Push the drain channel down to ensure the correct height.
6. Connect the drain flange to the sewer pipe. Run water through the drain and check for leaks.
7. Adjust the leveling feet to level and stabilize the shower drain unit. The top of the drain channel should be flush with the surface of the finished floor.
8. Complete the installation by installing the preferred flooring.





## Shower Drain Installation Instructions



### PREPARATION

- **Before Installation**  
Before installing any Alfi Brand product in your home, you should make sure that you are in compliance with all local plumbing codes and regulations.
- **Check The Accessory Items**  
Before installation, please check the condition of the product and, if appropriate, its components. If there is any problem with the product and/or its components, please contact the store you purchased it from for a replacement. As soon as you have inspected your product, please return it to its original packaging until you are ready to install it.
- **Handle With Care**  
To protect its finish and avoid damage before and after installation, please handle the product with care. For care and cleaning tips after installation, please refer to the *Care and Cleaning Guide* in this instruction guide.

### MATERIALS & TOOLS

Safety glasses, assorted screwdrivers, silicone sealant, flooring mortar, level, and other tools as needed

### INSTALLATION FOR SQUARE SHOWER DRAINS

\*IMPORTANT: Recommended for professional installers only. The installer maintains responsibility for installing the product safely.  
 \*Drawings are for reference only. Please refer to actual product for exact size, shape and parts.

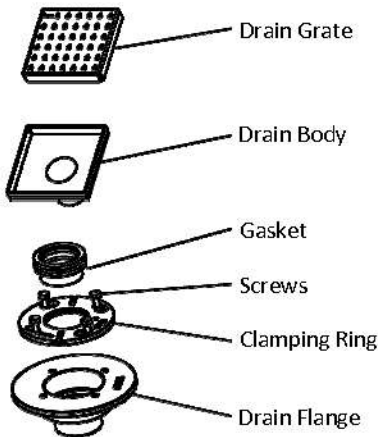

1. Determine the desired position of the shower drain.  
Relocate rough-in pipework if necessary. Cover with flooring mortar as needed.

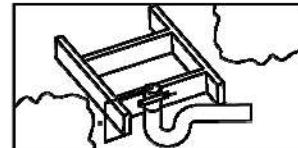

2. Assemble the drain grate to the drain body.

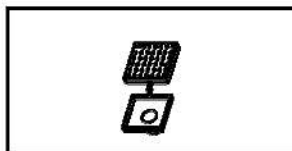

3. Assemble the clamping ring to the drain flange, and then install the gasket into the drain flange.  
Fasten the assembly with the screws.



4. Insert the drain body into the gasket.  
Push the drain body down to ensure the correct height.

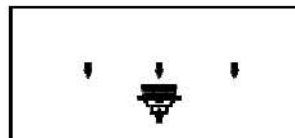

5. Install the drain flange to the rough-in pipe.  
Run water through the drain and check for leaks.

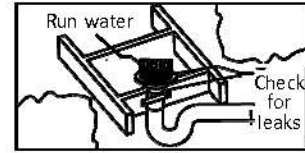
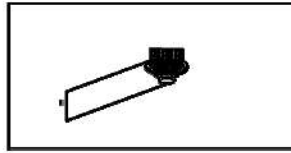

6. Adjust the shower drain unit to level and stabilize it.  
The top of the drain body should be flush with the surface of the finished floor.

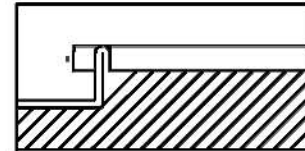
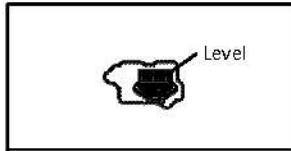

7. Apply a bead of silicone sealant around the outside of the shower drain.  
Complete the installation by installing the preferred flooring.

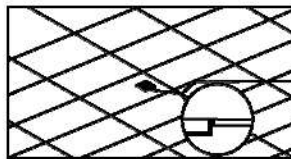

Silicone sealant

### INSTALLATION FOR LINEAR SHOWER DRAINS

**\*IMPORTANT:** Recommended for professional installers only. The installer maintains responsibility for installing the product safely.

\*Drawings are for reference only. Please refer to actual product for exact size, shape and parts.

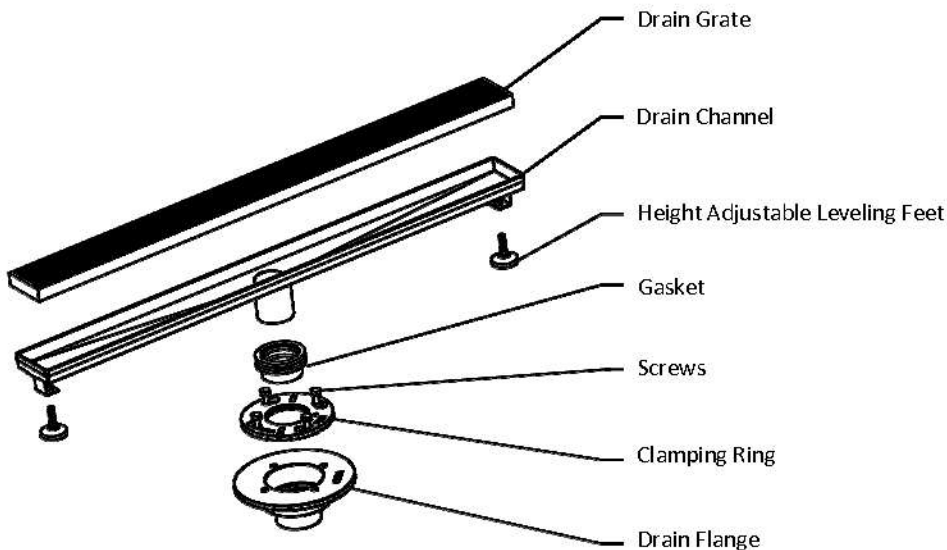

1. Determine the desired position of the shower drain.  
Relocate rough-in pipework if necessary. Cover with flooring mortar as needed.

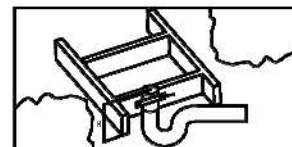

2. Assemble the drain grate to the drain channel.

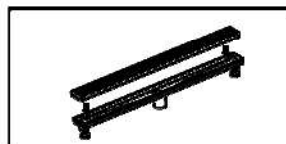

3. Assemble the clamping ring to the drain flange, and then install the gasket into the drain flange.  
Fasten the assembly with the screws.

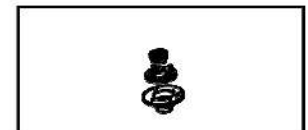

4. Insert the drain channel into the gasket.  
Push the drain channel down to ensure the correct height.

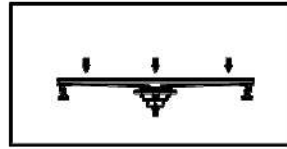

5. Install the drain flange to the rough-in pipe.  
Run water through the drain and check for leaks.

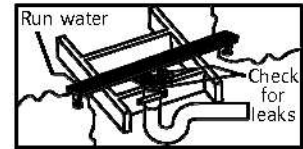
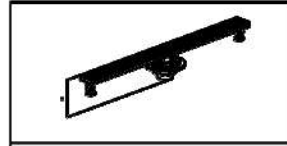

6. Adjust the leveling feet to level and stabilize the shower drain unit.  
The top of the drain channel should be flush with the surface of the finished floor.

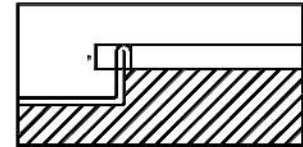
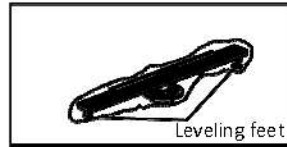

7. Apply a bead of silicone sealant around the outside of the shower drain.  
Complete the installation by installing the preferred flooring.

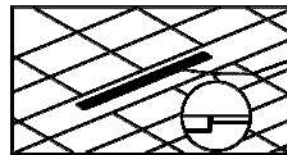

Silicone sealant

**CARE AND CLEANING GUIDE**

Alfi Brand stainless steel shower drains are designed to minimize cleaning and maintenance. High-pressure flushing is the most effective method of cleaning, and, if performed regularly, will keep the drains clean in most situations. Only use a mild soap and a soft cloth for cleaning. **DO NOT** use any abrasive cleaners or scrub pads. **DO NOT** allow household cleaning agents, such as bleach, sit on your drain cover for a long period of time. In cases where a stainless steel cleaner is necessary, rinse the drains with plenty of water after use.