

INSTALLATION INSTRUCTIONS

Step 1: Drill Holes in Wall for screws or screw anchors and attached Mounting Bracket to Wall

Determine your desired location for installation and make a mark for the location of the mounting bracket. Remove mounting Bracket from backplate by loosening set screw in backplate as pictured below. Place center hole of mounting bracket over mark made above. Make 4 marks where mounting screws will be placed as shown below. Drill hole at each of the marks. (You may substitute other style mounting anchors or screws if desired). Place anchors into the holes made. Slip backplate and post onto mounting bracket. After straightening the post into position, tighten the set screw to secure.

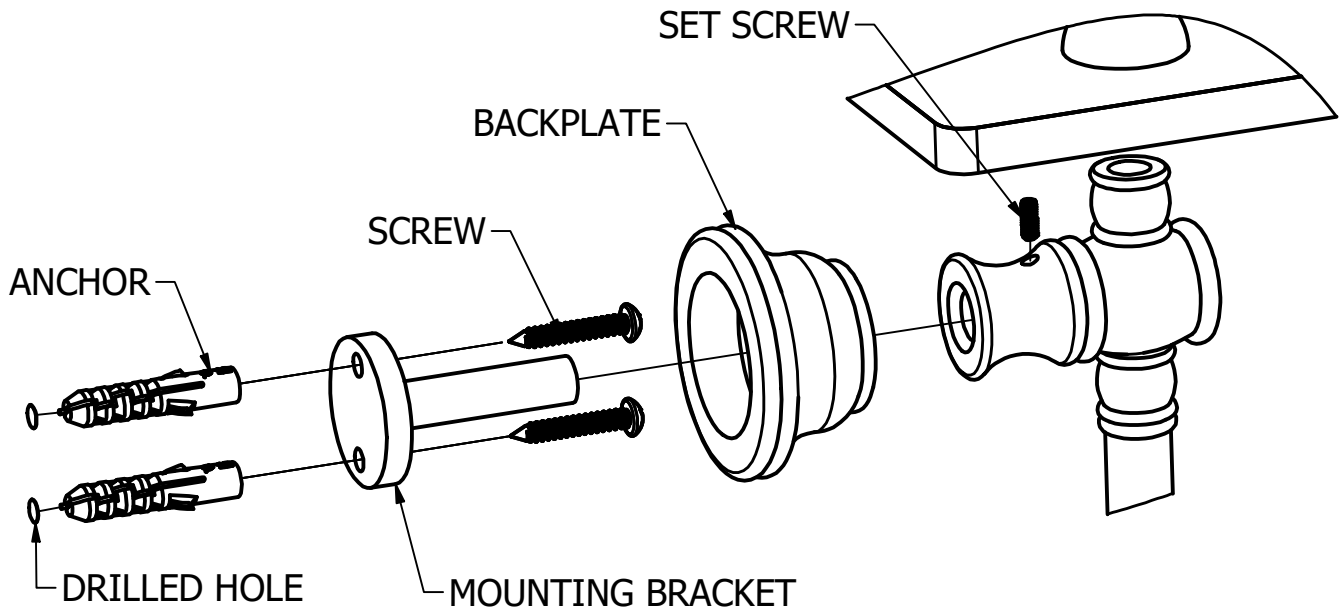
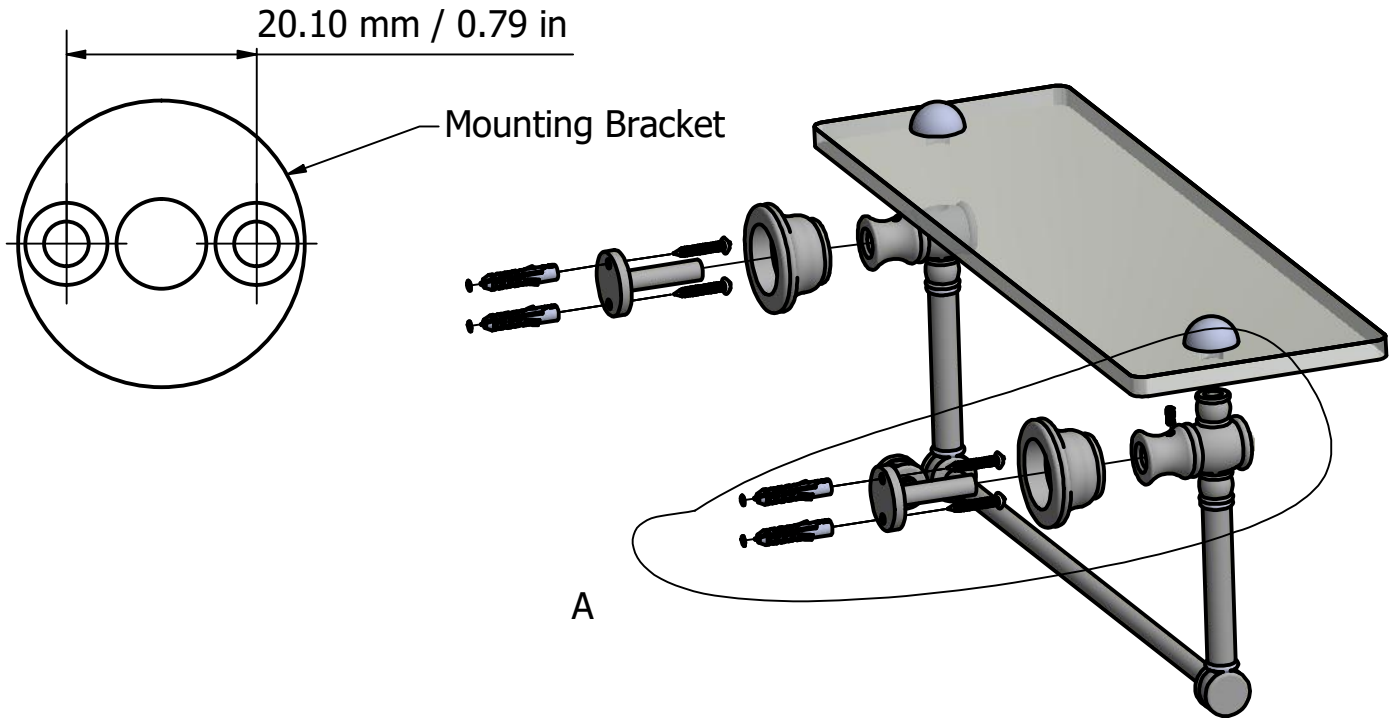

DETAIL A