

Hood Installation

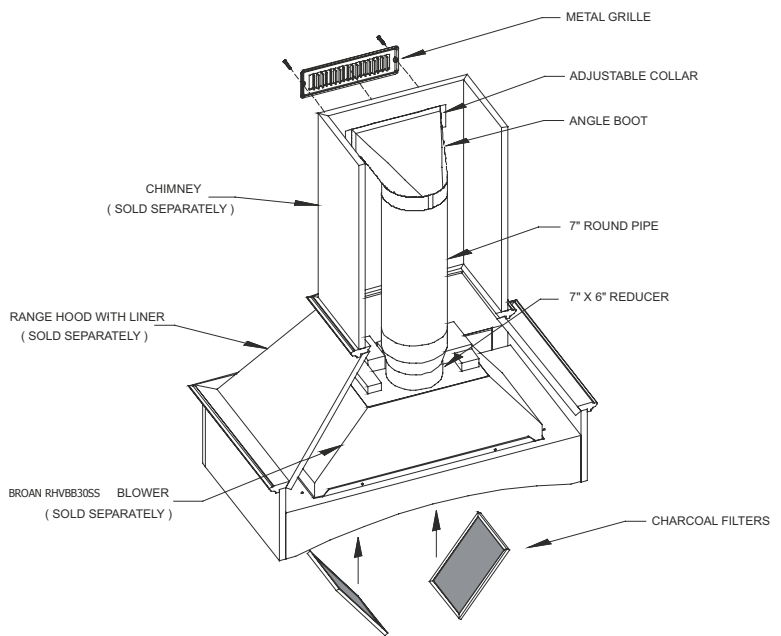

EASY TO INSTALL

USING OUR PATENT PENDING DESIGN

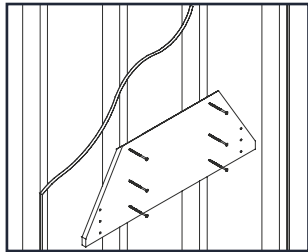

Step 1:
Screw mounting plate to wall

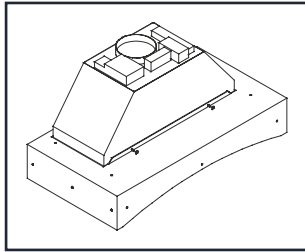

Step 2:
Assemble blower unit (sold separately) to metal liner

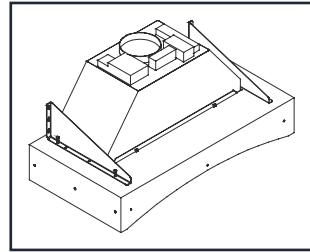

Step 3:
Fasten metal mounting brackets to liner

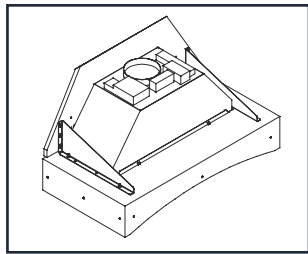

Step 4:
Hang the liner/bracket assembly on the mounting plate (make all electrical and ventilation connections at this point)

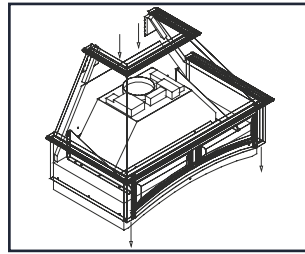

Step 5:
Slip the wood range hood on top of the mounting plate

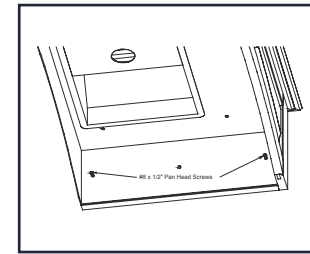

Step 6:
Fasten wood range hood to liner with (4) screws

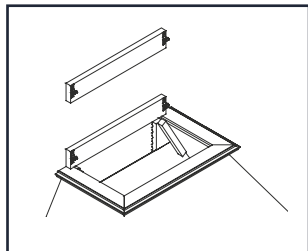

Step 7:
If using a chimney (sold separately) mount blocks to wall

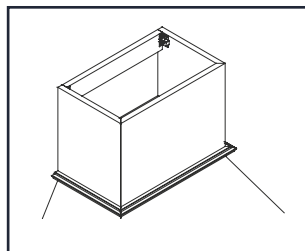

Step 8:
Snap chimney in place

