

### TRANSITIONS

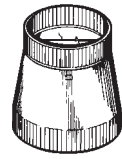

- Model 411 Transition**  
 ● 3¼" x 10" to 6" round  
**Model 412H Transition**  
 ● 3¼" x 10" to 7" round  
**Model 413 Transition**  
 ● 3¼" x 10" to 8" round

All models above -  
 30 GA galvanized steel  
 construction

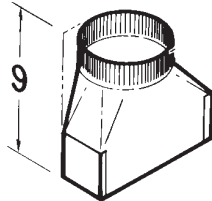

- Model 423 Transition**  
 ● 4½" x 18½" to 10" round  
 - vertical discharge  
 ● 26 GA galvanized steel  
 construction

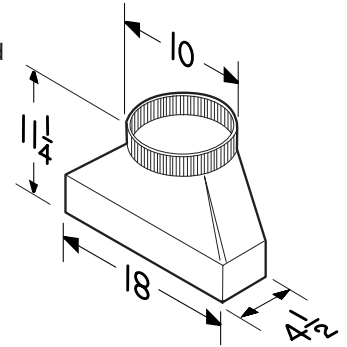

- Model 414 Transition**  
 ● 10" round to 8" round  
 ● 24 GA galvanized steel

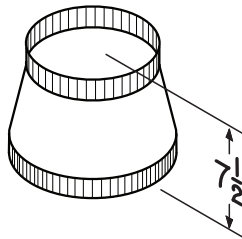

- Model 424 Transition**  
 ● 4½" x 18½" to 10" round  
 horizontal, rear discharge  
 ● 26 GA galvanized steel  
 construction

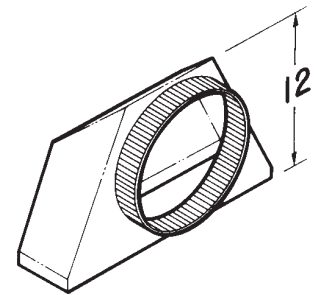

- Model T486 Transition**  
 ● 8" round to 6" round  
 ● 30 GA galvanized steel

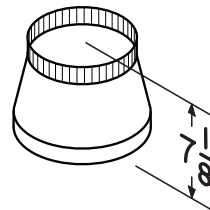

- Model 427 Transition**  
 ● 4½" x 18½" to 10" round  
 horizontal discharge  
 ● 26 GA galvanized steel  
 construction

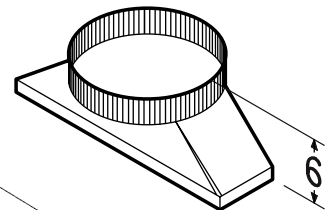

- Model T487 Transition**  
 ● 8" round to 7" round  
 ● 24 GA galvanized steel

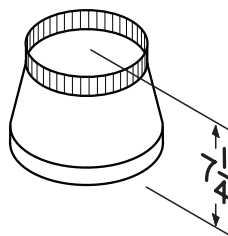

- Model 453 Transition**  
 ● 4½" x 18½" to 10" round horizontal,  
 left discharge  
 ● 26 GA galvanized  
 steel construction

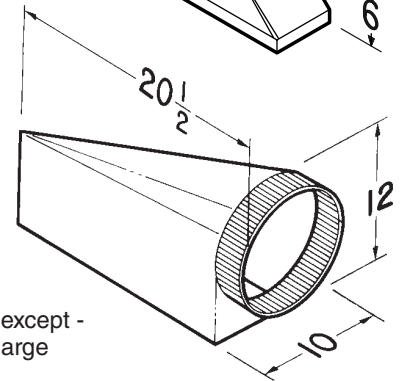

- Model 454 Transition**  
 ● Same as Model 453 except -  
 horizontal right discharge

REFERENCE	QTY.	REMARKS	Project
			Location
			Architect
			Engineer
			Contractor
			Submitted by Date

**Model 459 Transition**

- 3 1/4" x 14" to 8" round - vertical discharge
- 30 GA galvanized steel construction

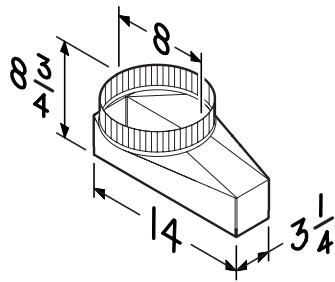

**Model T460 Transition**

- 3 1/4" x 14" to 7" round - vertical discharge
- 30 GA galvanized steel construction

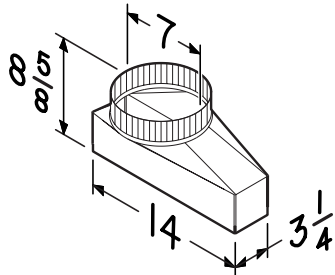

**Model T462 Transition**

- 3 1/4" x 14" to 6" round - vertical discharge
- 30 GA galvanized steel construction

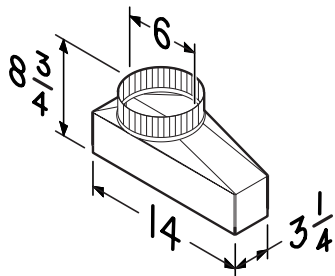

**Model 472 Transition / Damper**

- 10" round to 8" round
- Spring-loaded aluminum louvers
- Rubber stops
- 24 GA galvanized steel

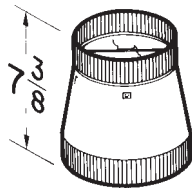

**Model 475 Transition**

- 6" round to 4" round
- Black, polymeric construction

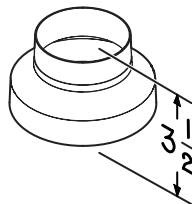

**Model 475B Transition**

- Six-pack of Model 475

**Model T81212 Transition**

- 8" x 12" to 12" round
- 28 ga. galvanized steel

