



## **Additional Information for Range Hoods meeting ADA Compliance**

Broan and NuTone branded residential range hoods can be installed to comply with Sections 308 and 309 of ADA Guidelines, when used with appropriately mounted controls installed at 15" to 48" above the floor and control access should not require reaching over a cooking appliance.

The following range hoods can work in an ADA Compliant situation when the range hood is wired to operate from a dedicated, standard electrical wall switch. To facilitate this application, share the information on the following pages with your electrician when preparing for the installation.

### **THIS PROCEDURE APPLIES TO THE FOLLOWING RANGE HOOD SERIES**

**Broan Series:** BCDF, BKDB, BCDA, BKDD, BKDEG, BKDF, CLDA, CRDEG, BNDD, BNDF and BQDD

**NuTone Series:** AHDA, AVDF, NKDF, NQDD and NCDA

**ADA LOW VOLTAGE WIRING INSTRUCTIONS FOR SINGLE BLOWER RANGE HOODS (PAGE 1 AND 2)  
AND DOUBLE BLOWER RANGE HOODS (PAGE 3 TO 5)**

**⚠ WARNING**

**For residential (domestic) installation only. Before proceeding, switch power off at service panel and lock service disconnecting means to prevent power from being switched on accidentally. Installation work and electrical wiring must be done by qualified person(s) in accordance with all applicable codes and standards, including fire-rated construction codes and standards. Also, it is recommended to wear safety glasses and gloves.**

NOTE: The illustrations in this procedure are generic; some hood details may slightly differ from the hood you have on hand but the procedure itself applies to all single blower range hoods listed in this document (see page 2).

- ❶ Remove filters from the hood and set them aside.
- ❷ Fold back the control access panel to access the control panel connections.

- ❸ Remove the wiring cover (shaded part in illustration below) retaining screw. Slide the wiring cover out of the hood and set it aside with its screw.

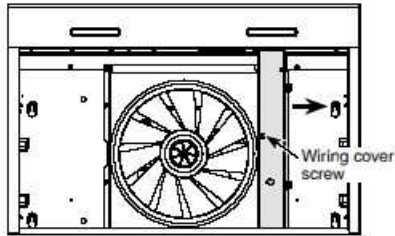

- ❹ Unplug the blower connector from the main harness.

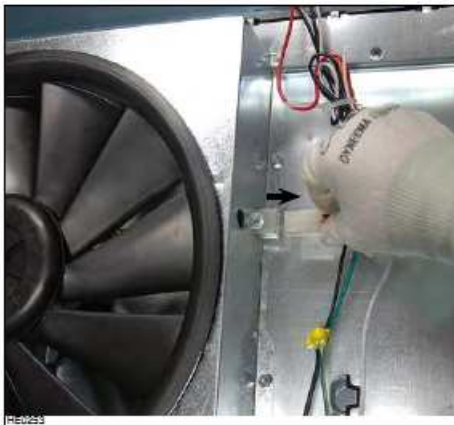

**CAUTION**  
**Use exclusively the cable included in this kit.**

- ❺ Measure 4 feet from the connector end of the provided ADA cable and cut the cable. Set aside the remaining 15-ft. cable section without connector; it will be used later (refer to step ❻). Run the connector of the ADA cable section through the wiring cable hole on the bent plate.

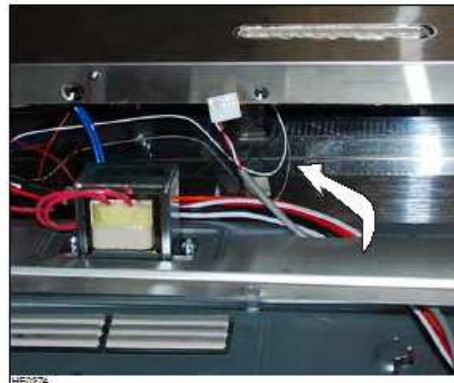

- ❻ Using a 11/32" socket, remove the 6 nuts retaining the blower chamber to the hood assembly (2 nuts on inner back and 2 other nuts per sides), then use a Phillips no. 2 screwdriver to remove both front corner screws. See picture below for nuts and screws locations. Pull the blower chamber out of the hood assembly and set it aside with its retaining screws and nuts.

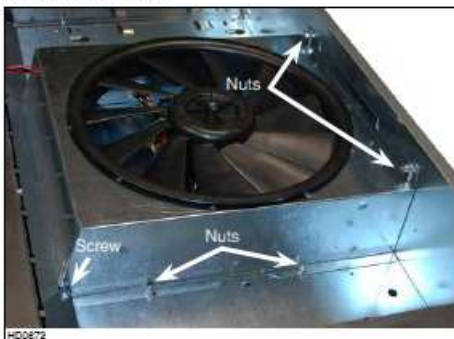

- ❼ Connect the ADA cable connector to the 6-pin connector on control board (circled on picture below).



- ❽ Secure the ADA cable section to the main harness using a tie-wrap.



- ❾ Remove and set aside the 4 front screws retaining the control access panel to the hood.





- ⑩ Close the control access panel and reinstall the blower by reversing steps ① to ③ on first page. Run the ADA cable section through the provided ferrite, making 2 loops. The ferrite must be as close as possible to the access panel.



- ⑪ Open the provided connection box. Using long nose pliers, break away 2 cable entry notches on the lid (one per side).



- ⑫ Peel off the paper backing on back of connection box base and install the base at the location shown. Make sure that the surface is clean. This will place the connection box within the Wire Cover area near the blower connector. **IMPORTANT NOTE:** The base must be positioned flush to the notches (see circled area below).

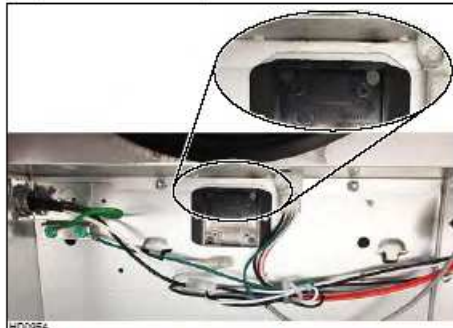

- ⑬ Use the remaining cable length of 15 ft. (from step ⑩) to connect to the remote ADA switch outside the hood (step ⑩). **IMPORTANT:** Leave a cable length of at least 12" that protrudes from the wall (at the same location of the 120 V house wiring). Run one end of the remaining section of the ADA cable through the range hood wire clamp, along with the power cable, giving enough length to make the connections inside the box. Tighten the wire clamp, then strip the end of the 3 wires from both ADA cable ends.

**NOTE:** The wire clamp must be suitable for 2 cables.



- ⑭ Using small UL approved wire nuts (suitable for 22 AWG wires), connect wires as follow: WHITE wire with WHITE wire, BLACK wire with BLACK wire and RED wire with RED wire.



- ⑮ Put the wire nuts inside the connection box base, then snap the connection box lid on its base, ensuring the ADA cable runs through the open notches.



- ⑯ Reinstall the hood wiring cover and attach it to the hood using its retaining screw.

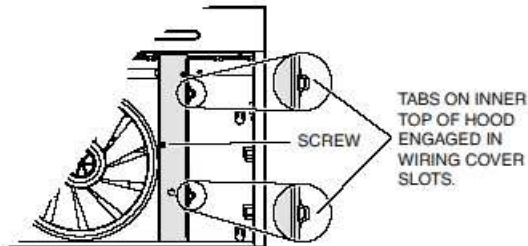

### CAUTION

Ensure both tabs on inner top of hood are engaged in their corresponding slots in wiring cover. Also, take care not to pinch wires while reinstalling wiring cover.

- ⑰ Install a momentary contact switch at a convenient place for the user. Connect the end without connector of the provided ADA cable to this switch as shown below:

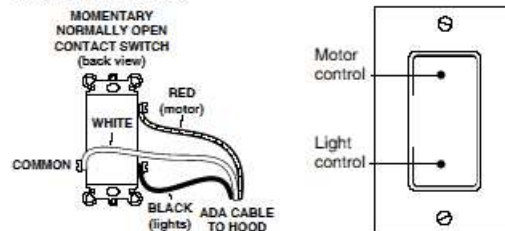

### CAUTION

Use one SPDT normally open, momentary contact switch (shown in above diagram) or two SPST normally open, momentary contact switch.

- ⑱ Put back in place the hood filters and restore power to the range hood.

## RANGE HOOD OPERATION

**NOTE:** Use the control on the range hood to reset the filter maintenance indicator.

### Motor control

Press to turn ON the blower on LOW speed.

**NOTE:** When LOW speed is activated from OFF, the blower starts on MEDIUM speed for a very short lapse of time, and then resumes to LOW speed.

To change the blower speed, press on this button again until the desired speed is reached (from LOW to MEDIUM to HIGH speed to OFF).

### Light control

When lights are OFF, press once on this control to turn ON the lights on LOW intensity. Press another time to set the lights on HIGH intensity. Pressing another time after the HIGH setting will turn OFF the lights.

## THIS PROCEDURE APPLIES TO THE FOLLOWING RANGE HOOD SERIES

Broan Series: BCDF, BKDB, BCDA, BKDD, BKDEG, BKDF, CLDA, CRDEG, BNDD, BNDF and BQDD.

NuTone Series: AHDA, AVDF, NKDF, NQDD and NCDA.

Venmar Chef Series: VCNDD and VCQDD.

Venmar Bistro Series: VBLDF.

# ADA LOW VOLTAGE WIRING INSTRUCTIONS FOR DOUBLE BLOWER RANGE HOODS

## ⚠ WARNING

For residential (domestic) installation only. Before proceeding, switch power off at service panel and lock service disconnecting means to prevent power from being switched on accidentally. Installation work and electrical wiring must be done by qualified person(s) in accordance with all applicable codes and standards, including fire-rated construction codes and standards. Also, it is recommended to wear safety glasses and gloves.

### ACCESS TO RANGE HOOD MAIN HARNESS

Due to their particular design, some range hood series have a different way to access to their main harness. These range hood series are: EPLEC with NPLEC series and EQLD series. For all other range hood series, go to page 4.

#### EPLEC SERIES AND NPLEC SERIES

- ❶ Remove both filters from the hood and set them aside.
- ❷ Remove both side fillers by removing the 3 screws holding each one of them. Slide each one towards the center of the hood and tilt it up to remove it completely. Set the fillers and screws aside.

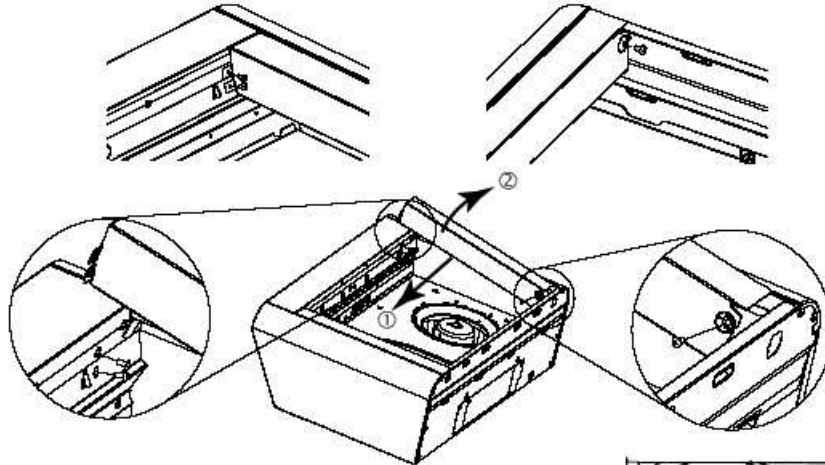

- ❸ Using a 11/32" nutdriver or socket, remove the lock nut retaining the flange of the right blower cover plate (shaded part on illustration at right) to the inner back of hood (see inset). Remove all cover plate retaining screws (7 screws), then set the blower cover along with its screws and nut aside.

NOTE: For 30 in.-wide hoods, slightly lift up the cover plate before sliding it towards the left to remove it.

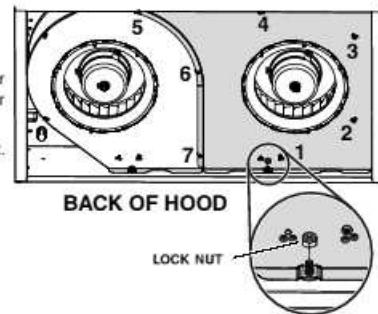

#### EQLD SERIES

- ❶ Grab the front edge of the panel and lift it to detach the panel from the front magnets (A). Remove the panel from the hood by tilting it slightly to disengage it from 3 hooks (B), then set aside the panel.

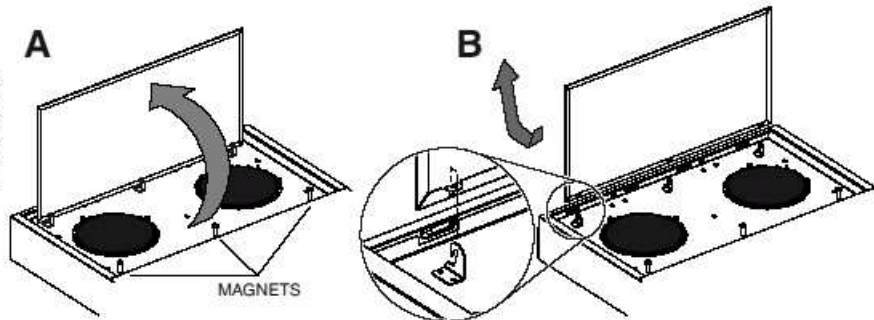

- ❷ Using a 11/32" nutdriver or socket, remove both lock nuts retaining the flange of the cover plate to the inner back of hood (see insets). Remove the cover plate retaining screws (9 screws), then set the blowers cover along with its screws and nuts aside.

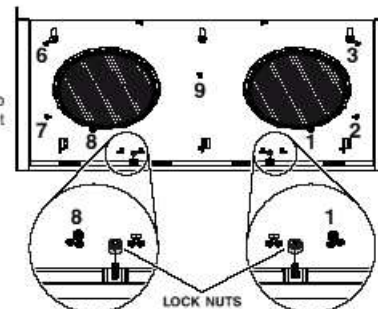



## ACCESS TO RANGE HOOD MAIN HARNESS (CONT'D)

### ALL OTHER RANGE HOOD SERIES

- 1 Remove filters from the hood and set them aside.

- 2 Using a 11/32" nutdriver or socket, remove the lock nut retaining the flange of the right cover plate (shaded part on illustration at right) to the inner back of hood (see inset). Remove the right cover plate retaining screws (7 screws), then set the blower cover along with its screws and nut aside.

NOTE: According to range hood models, screw 1 location may vary; it can be on right side of the +lock nut or on left side (see inset).

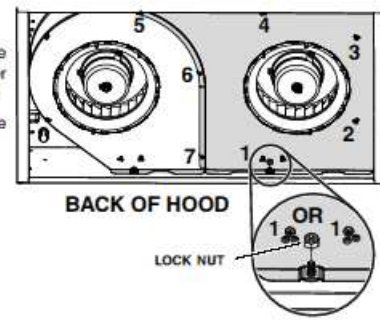

### ADA CABLE CONNECTIONS

- 1 Run the ADA cable (GREY cable coming out from the control access panel) through the provided ferrite, making 2 loops.



- 2 Open the provided connection box. Using long nose pliers, break away 2 cable entry notches on the lid (one per side).



- 3 Peel off the paper backing on back of connection box base and install this base on the inner back of the hood, near the power cable knock out, as shown below. Make sure that the surface is clean before installing the box.



### CAUTION

Use exclusively the cable included in this kit.

- 1 Cut off and discard the connector at the end of the provided ADA cable. Use this cable to connect to the remote ADA switch outside the hood (step 5).

IMPORTANT: leave a cable length of at least 12" that protrudes from the wall (at the same location of the 120 V house wiring).

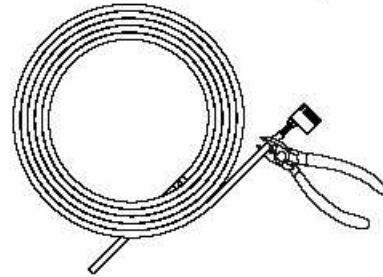

- 2 Run one end of the ADA cable through the range hood wire clamp, along with the power cable, giving enough length to make the connection inside the box. Tighten the wire clamp, then strip the end of the 3 wires from provided ADA cable.

NOTE: The wire clamp must be suitable for 2 cables.



- 3 Strip the end of the 3 wires from GREY cable (the one with ferrite), then using small UL approved wire nuts (suitable for 22 AWG wires), connect these wires with ADA cable wires. Connect as follow: WHITE wire with WHITE wire, BLACK wire with BLACK wire and RED wire with RED wire.

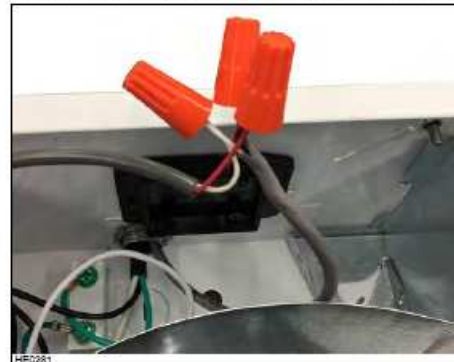

- Put the wire nuts inside the connection box base, then snap the connection box lid on its base, ensuring the ADA cable runs through the open notches.



- Install a momentary contact switch at a convenient place for the user. Connect the end of the provided ADA cable to this switch as shown below:

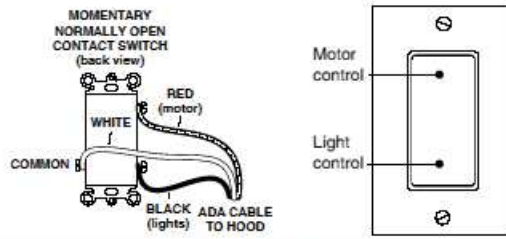

**CAUTION**

Use one SPDT normally open, momentary contact switch (shown in above diagram) or two SPST, normally open momentary contact switch.

- Reinstall the blower cover and filters, by reversing appropriate steps according to the range hood series (see page 4 or 5).
- Restore power to the range hood.

## RANGE HOOD OPERATION

### RANGE HOODS WITH CAPTOUCH CONTROL

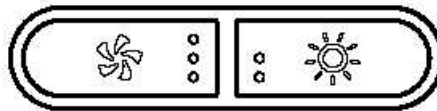

NOTE: Use the control on the range hood to reset the filter maintenance indicator.

#### MOTOR CONTROL

Press to turn ON the blower on LOW speed.

NOTE: When LOW speed is activated from OFF, the blower starts on MEDIUM speed for a very short lapse of time, and then resumes to LOW speed.

To change the blower speed, press on this button again until the desired speed is reached (from LOW to MEDIUM to HIGH speed to OFF).

#### LIGHT CONTROL

When lights are OFF, press once on this control to turn ON the lights on LOW intensity. Press another time to set the lights on HIGH intensity. Pressing another time after the HIGH setting will turn OFF the lights.

### RANGE HOODS WITH LCD CONTROL



- NOTES:
- The Delay OFF and the Master ON/OFF functions are not available when using the momentary contact switch.
  - Use the control on the range hood to reset the filter maintenance indicator.

#### MOTOR CONTROL

Press to turn ON the blower on LOW speed.

NOTE: When LOW speed is activated from OFF, the blower starts on MEDIUM speed for a very short lapse of time, and then resumes to LOW speed.

To change the blower speed, press on this button again until the desired speed is reached (from LOW to MEDIUM to HIGH speed to OFF).

#### LIGHT CONTROL

When lights are OFF, press once on this control to turn ON the lights on LOW intensity. Press another time to set the lights on MEDIUM intensity. Press another time to set the lights on HIGH intensity. Pressing another time after the HIGH setting will turn OFF the lights.

### RANGE HOODS WITH INFRARED CONTROL



- NOTES:
- The Delay OFF and the Master ON/OFF functions are not available when using the momentary contact switch.
  - Use the control on the range hood to reset the filter maintenance indicator.

#### MOTOR CONTROL

Press to turn ON the blower on LOW speed.

NOTE: When LOW speed is activated from OFF, the blower starts on MEDIUM speed for a very short lapse of time, and then resumes to LOW speed.

To change the blower speed, press on this button again until the desired speed is reached (from LOW to MEDIUM to HIGH speed to OFF).

#### LIGHT CONTROL

When lights are OFF, press once on this control to turn ON the lights on LOW intensity.

To change the light intensity, press on this button again until the desired intensity is reached (from LOW to MEDIUM to HIGH to OFF).