

# Hood Installation

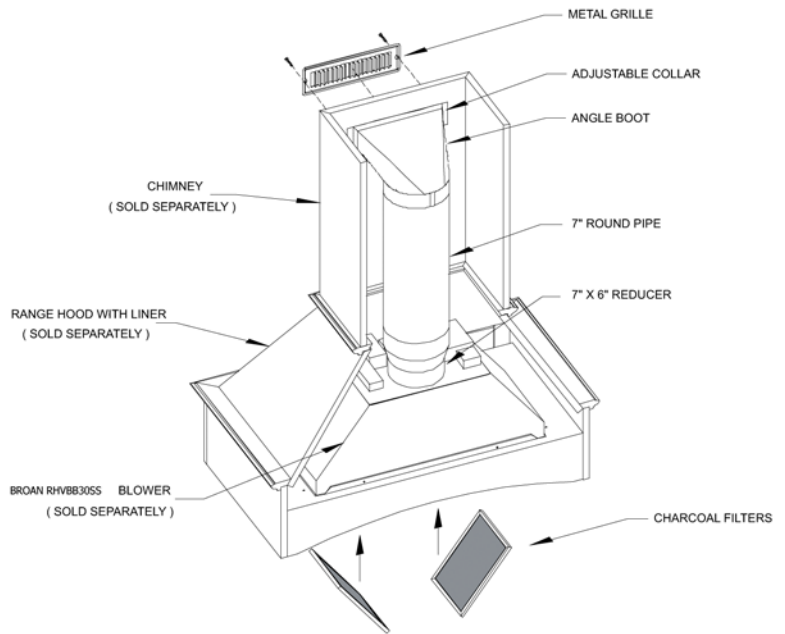

**EASY TO INSTALL**

**USING OUR PATENT PENDING DESIGN**

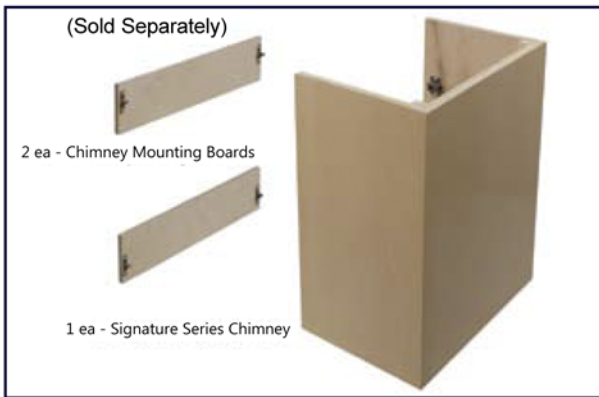
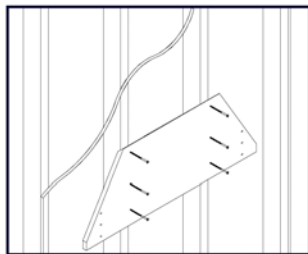

**Step 1:**  
Screw mounting plate to wall

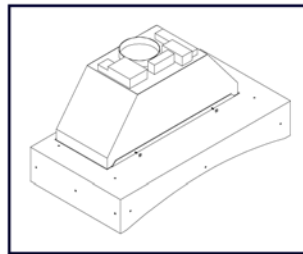

**Step 2:**  
Assemble blower unit (sold separately) to metal liner

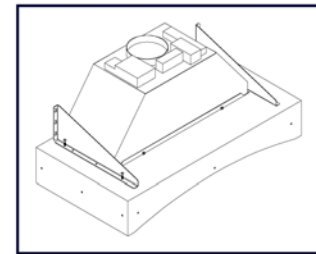

**Step 3:**  
Fasten metal mounting brackets to liner

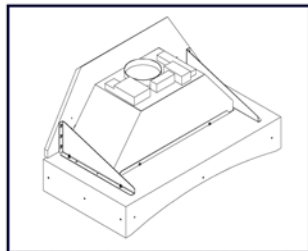

**Step 4:**  
Hang the liner/bracket assembly on the mounting plate (make all electrical and ventilation connections at this point)

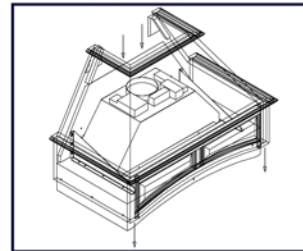

**Step 5:**  
Slip the wood range hood on top of the mounting plate

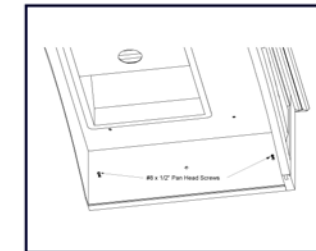

**Step 6:**  
Fasten wood range hood to liner with (4) screws

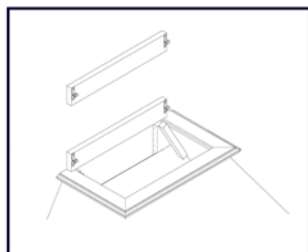

**Step 7:**  
If using a chimney (sold separately) mount blocks to wall

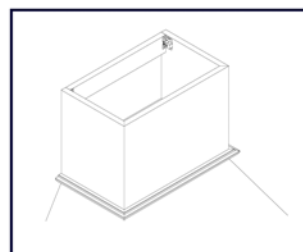

**Step 8:**  
Snap chimney in place

**kitchensource.com**  
1.800.667.8721

