

# FMC8010-BE/8058-BE/8090-BE MEDICINE CABINET INSTALLATION GUIDE

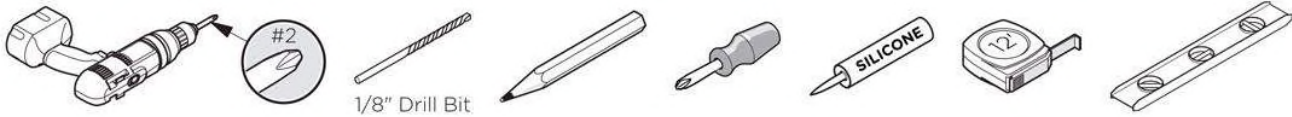

## TOOLS REQUIRED FOR ASSEMBLY



## SUPPLIED PARTS

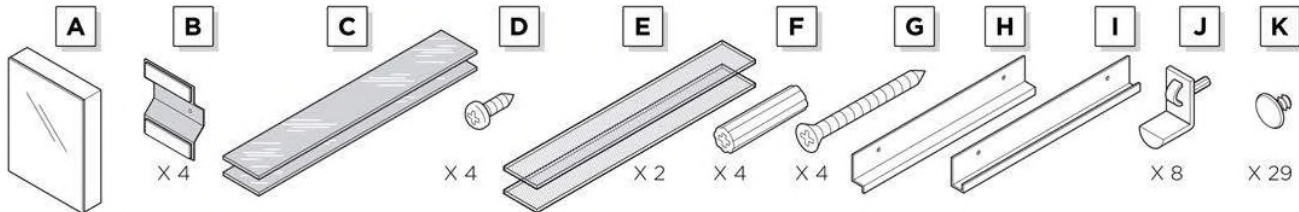

## MEDICINE CABINET DIMENSIONS

Model SKU	Width <b>A</b>	Height <b>B</b>	Depth
<b>FMC8058-BE</b>	19 1/2"	26"	5"
<b>FMC8090-BE</b>	29 1/2"	26"	5"
<b>FMC8010-BE</b>	39 1/2"	26"	5"

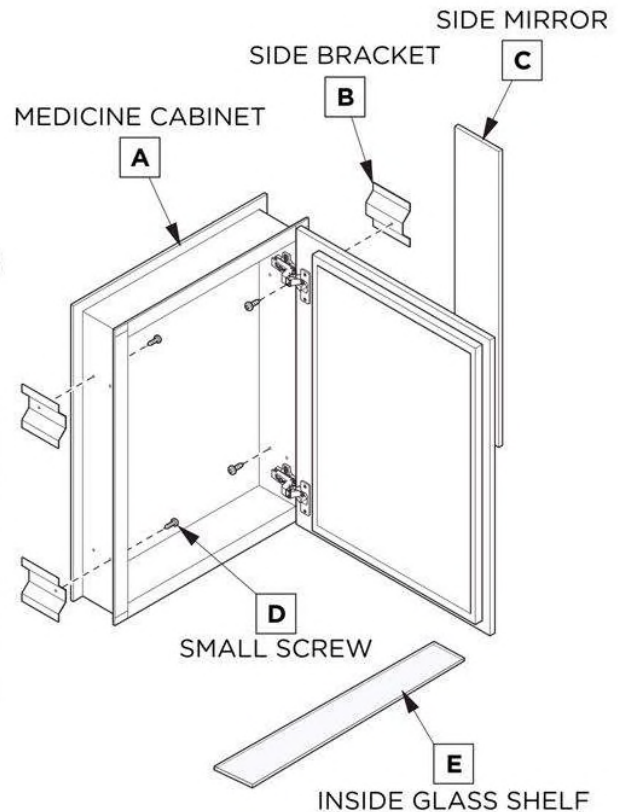
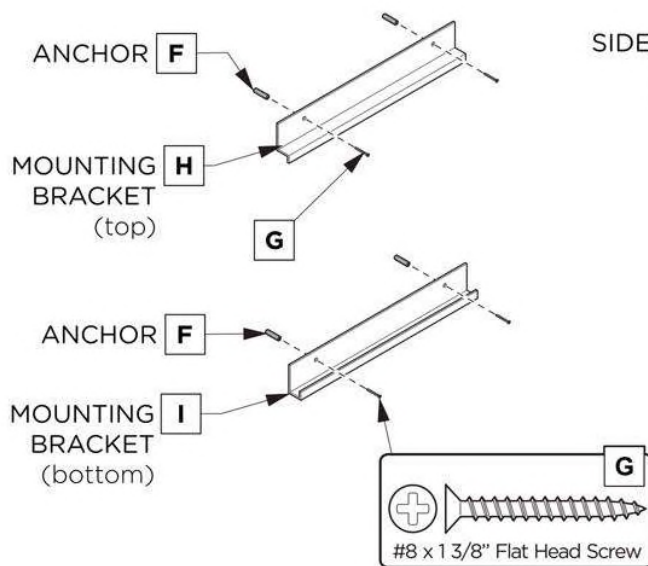

**∴kitchensource.com**  
1.800.667.8721



ALL DIMENSIONS & SPECIFICATIONS ARE APPROXIMATE AND SUBJECT TO CHANGE WITHOUT NOTICE.



RISK OF PROPERTY DAMAGE. USE ANCHORS RATED FOR THE LOADED WEIGHT OF THE PRODUCT. REFER TO THE ANCHOR MANUFACTURER'S INSTRUCTIONS.





# FMC8010-BE/8058-BE/8090-BE MEDICINE CABINET INSTALLATION GUIDE



## SURFACE-MOUNT INSTALLATION

**1**

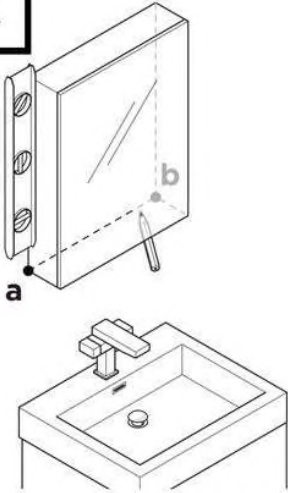

Level and mark the medicine cabinet's location on the wall from point **a** to point **b**.

**2**

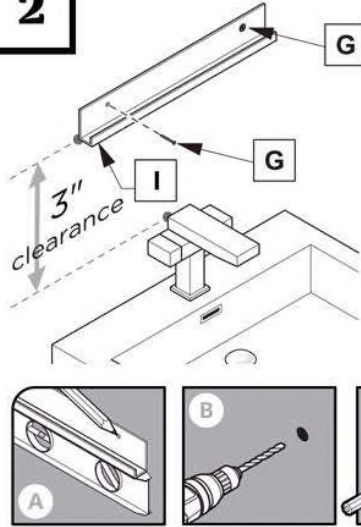

Level and mark.

Drill the holes in the wall with a 3/16" drill bit.

Insert the anchors in the holes.

Attach bottom bracket to the wall.

**IMPORTANT:**  
Consult an expert for the proper screws/bolts to use when attaching to various constructions. Screws provided **do not** attach to all wall construction types. Anchors are not required if brackets are installed in stud.

**3**

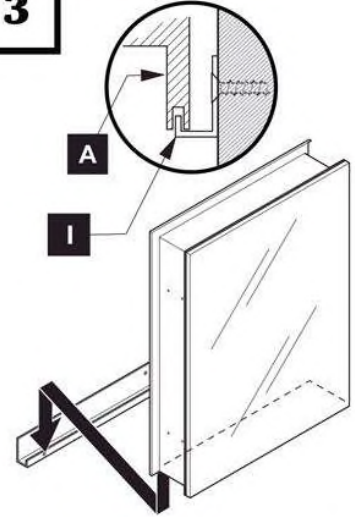

With assistance, rest the medicine cabinet on the bottom mounting bracket and hold it in place.

**4**

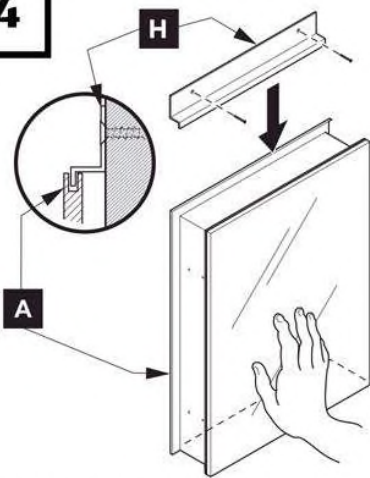

Hold the medicine cabinet (**A**) while it's placed on the bottom bracket, then secure by fitting the top bracket (**H**) on top of the medicine cabinet, and attach the top bracket (**H**) to the wall.

**5**

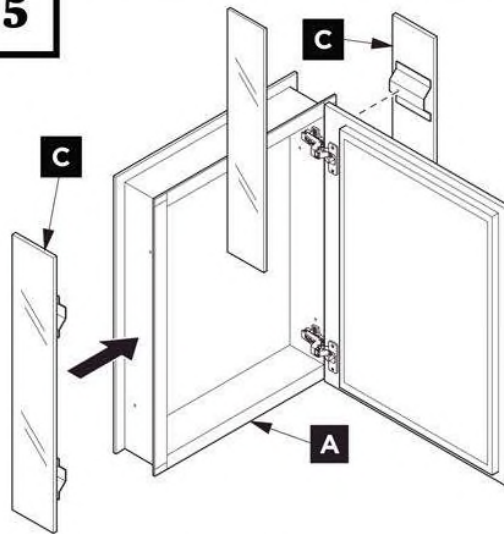

Align mirrored side panels (**C**) to each side of the medicine cabinet.

**6**

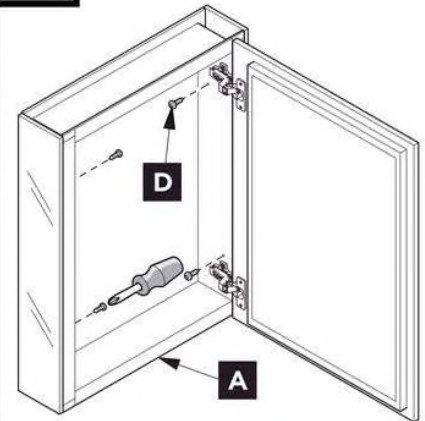

Attach mirrored side panels to the medicine cabinet using a screwdriver and provided screws (**D**).

**7**

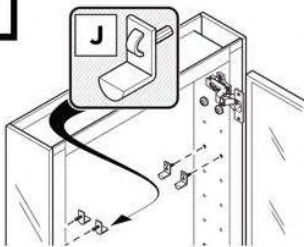

Push and twist the snap-in pins (**J**) into place.

**8**

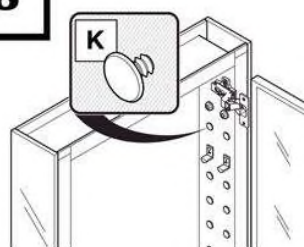

Fill remaining holes with the plugs (**K**).

**9**

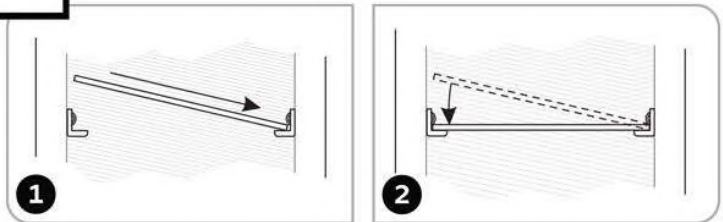

Push a side of the shelf (**E**) into left or right pins (**J**).

Snap the shelf (**E**) down into the opposite side.





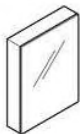

# FMC8010-BE/8058-BE/8090-BE MEDICINE CABINET INSTALLATION GUIDE



## RECESS-MOUNT INSTALLATION

**1**

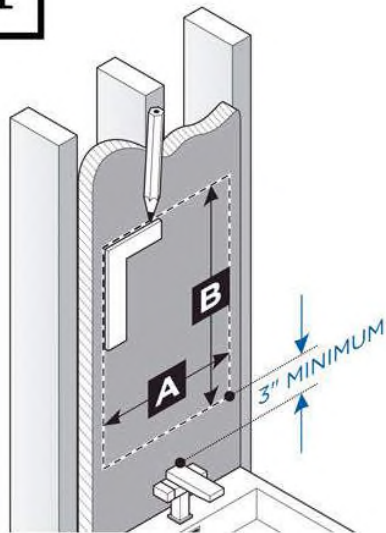

Draw the perimeter of the medicine cabinet on the wall.

**2**

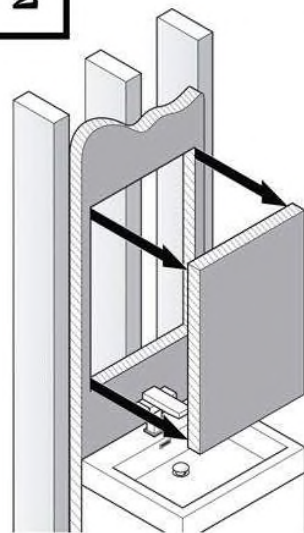

Place and hold the medicine cabinet in the cutout opening.

**3**

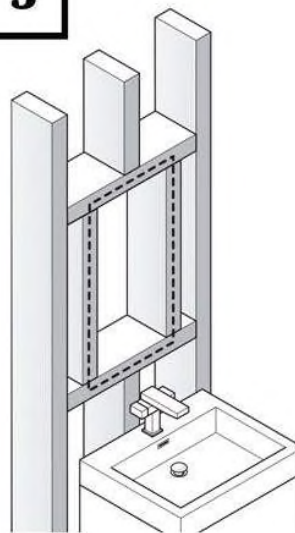

Frame the cutout opening.

**4**

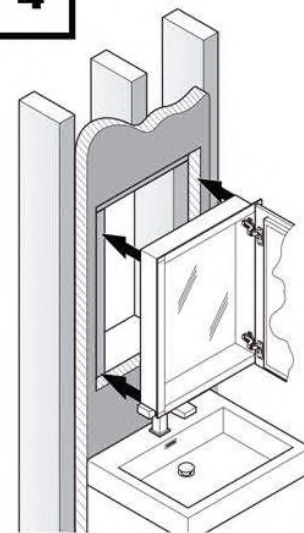

Cut the marked perimeter with appropriate tool.

### ROUGH IN DIMENSIONS

Model SKU	Width A	Height B	Depth
FMC8058-BE	18 3/4"	25 1/8"	3 3/4"
FMC8090-BE	28 5/8"	25 1/8"	3 3/4"
FMC8010-BE	38 3/8"	25 1/8"	3 3/4"

### 4 STEPS TO FRAME THE CUTOUT OPENING

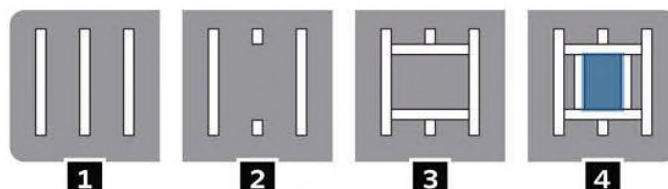

**5**

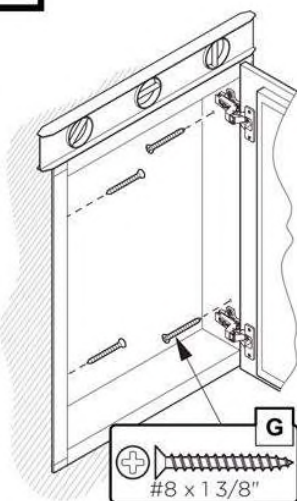

Level, then secure the medicine cabinet with the screws (G) through the mounting holes into the framing studs.

**6**

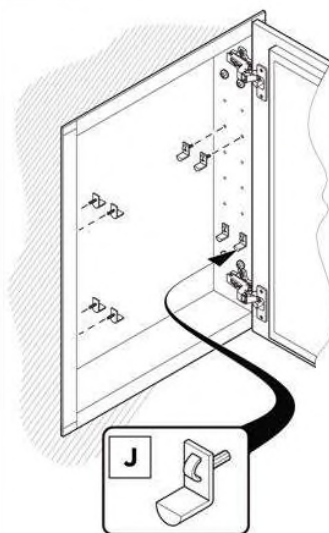

Choose the position for your shelves then push and twist the snap-in pins (J) into place.

**7**

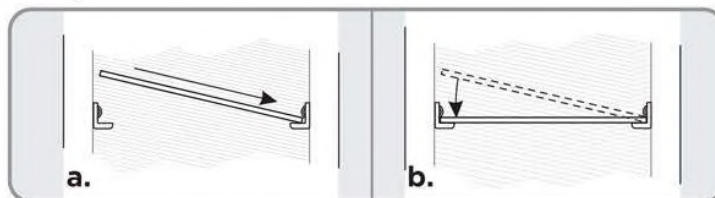

a. Push a side of the glass shelf (C) into left or right pins (J).  
b. Snap the glass shelf (C) into the opposite side.  
c. Fill remaining holes with the plugs (K).

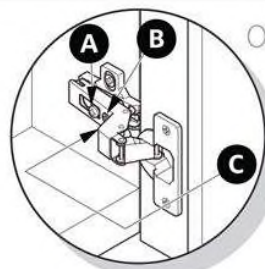

Illustration A.

### OPTIONAL DOOR ADJUSTMENT:

- A** This screw allow you to adjust pitch side to side.
- B** This screw releases cabinet's door and allows up and down adjustment.
- C** This screw allow you to adjust the gap between doors.

