

Metal Hub Plastic Round Lazy Susans Installation Instructions for the PLSMRxx Series

hardware
resources®



IMPORTANT:

Before you begin, make sure you familiarize yourself with all the parts and fully read the instructions.

CUSTOMER SERVICE:

Toll-free customer help line available weekdays between 7:00am and 6:00pm Central Time at 800-463-0660.

TOOLS NECESSARY:

Screw gun or Phillips screwdriver and tape measure. NOTE: If screw gun has a clutch, set to lowest setting so as not to over tighten and/or strip screws.

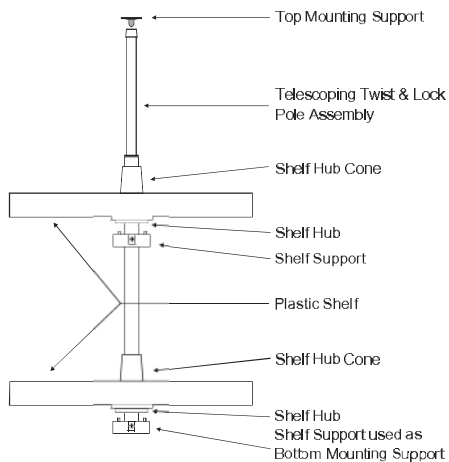

#8 x 3/4" Flat Head Phillips Wood Screw	4X
#8 x 5/8" Pan Head Phillips Wood Screw	4X
#8 x 1/2" Flat Head Machine Screw	6X
Telescoping Twist-Lock Pole Assembly	1X
Round Shelf	2X
Shelf Support	2X
Shelf Hub	2X
Shelf Hub Cone	2X
Top Mounting Support	1X

STEP 1

Measure and Mount Supports

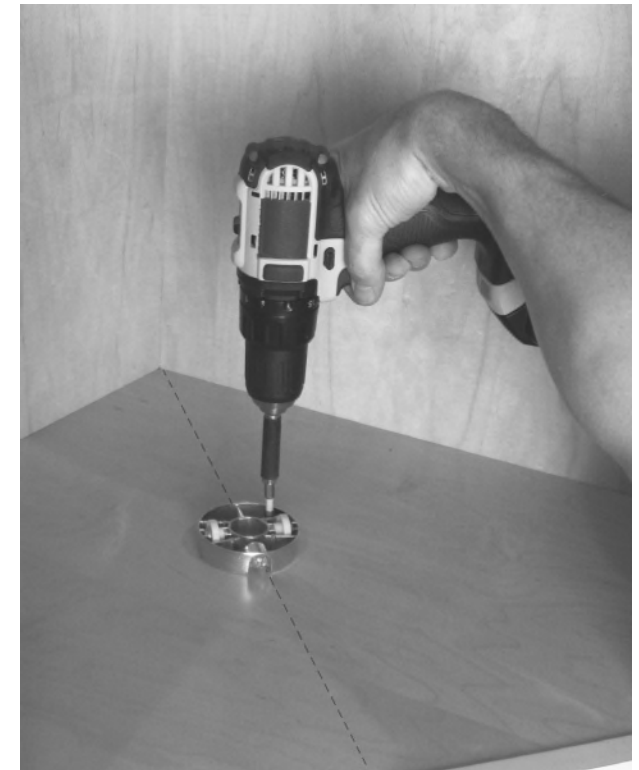
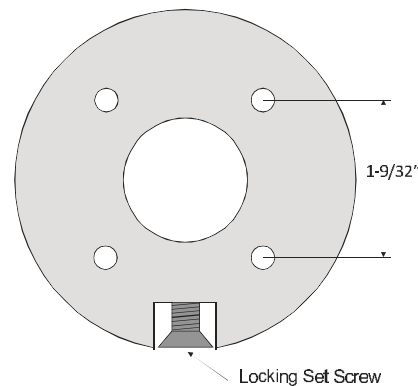
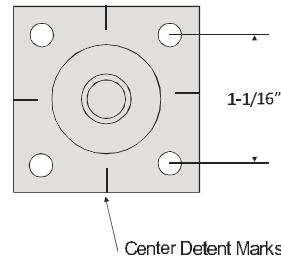

Mark layout for lower mounting support by placing a shelf in the cabinet. Center the shelf on the bottom of the cabinet making sure you have proper clearance from cabinet walls and door. Mark the mounting location by tracing around the hole in the middle of the shelf. Measure the center of the bottom mounting location and transfer to the top of the cabinet. Align Top Mounting Support with center detent marks and install with four (4) - #8 x 5/8" Pan Head Phillips Wood Screws. Place one (1) Shelf Support on the lower marks and secure with four (4) - #8 x 3/4" Flat Head Phillips Wood Screws to the bottom of the cabinet as shown (align set screw as shown).

STEP 2 - Install Hubs

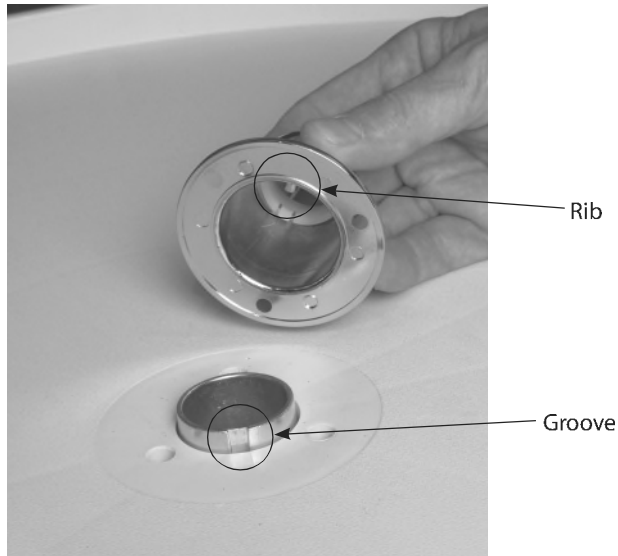

Insert one Shelf Hub through the bottom of a shelf as shown. Place one Shelf Hub Cone on the top of the shelf and fasten using (3) #8 x 1/2" Flat Head Machine Screws provided. NOTE: Make sure the rib inside the Shelf Hub Cone is aligned with the groove in the hub (see picture). Repeat with second shelf.

STEP 3 - Shelf Assembly



From the top slide one shelf, the other Shelf Support, and then the other shelf onto the Pole Assembly. Slide bottom of Pole Assembly into the Bottom Mounting Support.

STEP 4 - Pole Extension

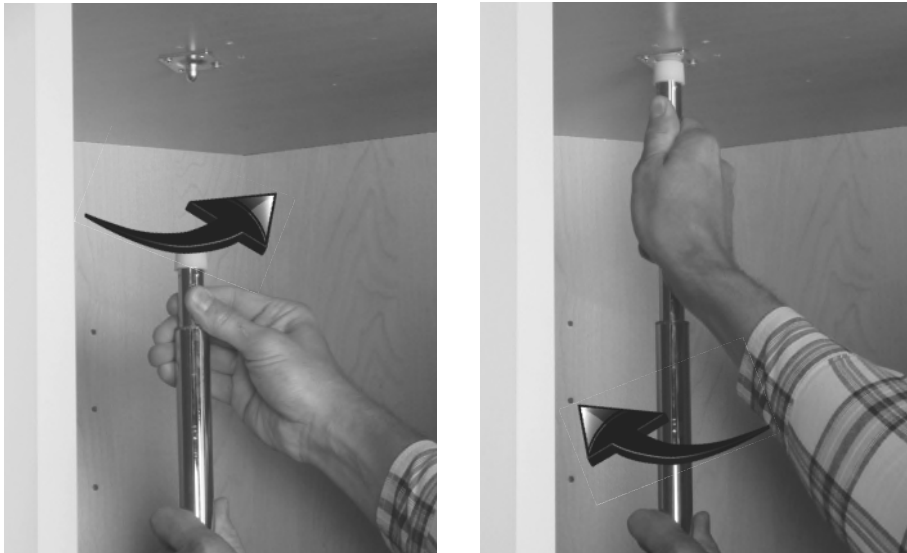

Holding onto the lower pole, twist the upper pole counter-clockwise to release. Extend pole upwards until it rests firmly against the Top Mounting Support and tighten by turning the upper pole clockwise.

STEP 5 - Shelf Adjustment

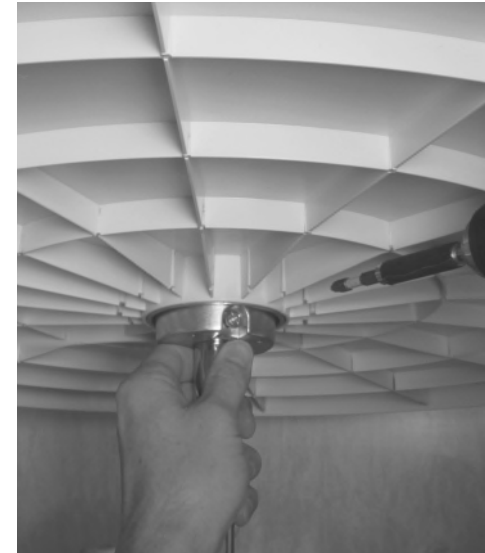

Raise upper shelf to desired height and tighten the Locking Set Screw. Raise the lower shelf and tighten the lower Locking Set Screw.