

TM40-FS-301912

ProTerra M40

Fireclay kitchen sink

Molded

With rounded corners [0,40"]

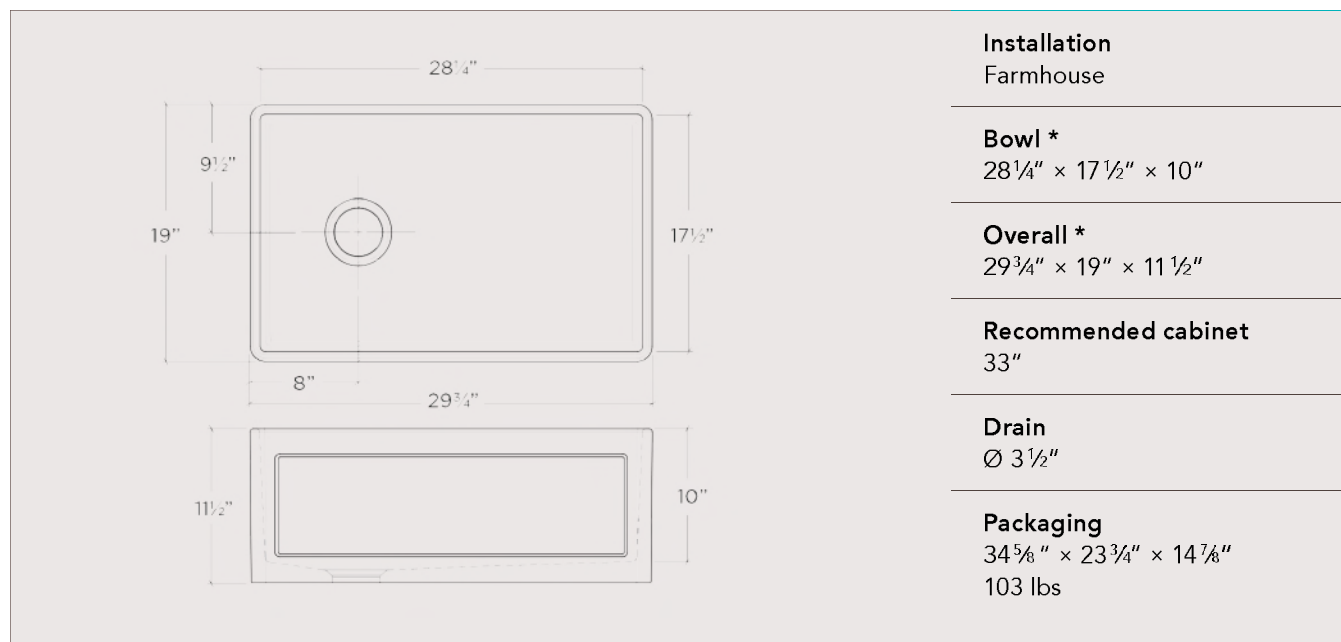

* Product dimensional variability $\pm 3/16$ ", due to manufacturing process

Features

- Designed in Canada, handcrafted in Italy
- Reversible apron front design: flat or shaker style
- Deep 10" bowl and 3/4" thick walls for optimized workspace
- Resistant to scratches and chips thanks to the fusion of glaze and fireclay
- Non-porous finish, hygienic and easy to clean
- Product dimensional variability $\pm 3/16$ ", due to manufacturing process
- Made of fireclay and glazed on all sides, white gloss finish
- Offset center 3-1/2" drain
- Sloped bottom for maximized drainage
- Waste disposal unit compatible, recommended to confirm waste disposal or drain maximal thickness specifications
- No template provided, recommended to have the sink on hand for final sizing of cabinet and countertop
- ASME A112.19.2/CSA B45.1

Must-have accessories



Grid
 TM40-G-2817

Warranty

Prochef offers a FIVE (5) YEAR LIMITED WARRANTY on the fixed components of its fireclay sinks, ensuring them against defect of material and workmanship and against fading/staining. This warranty is limited to defects or damages resulting from a normal residential use. For further details on our product warranty, please refer to our catalog or Website.