

# JULIEN

Donnez vie à vos idées.  
Make your ideas real.

## SPECIFICATIONS

Category: **Kitchen sink**

MODEL: **3259**

Type: **Undermount Single Bowl**

Collection: **Classic™**

### FEATURES:

- Handcrafted in Canada using recycled American stainless steel
- Commercial grade - 16 ga material thickness
- Corrosion resistant 304 series stainless steel (18/10)
- Elegant no. 4 brushed finish (appliance finish)
- Highly efficient sound deadening pads
- Practical flat sink bottom and straight bowl sides
- Stylish and functional bowl bottom grooves
- Optional in-bowl storage drawer
- Rear 3-1/2" drain placement
- Limited lifetime warranty

### STANDARDS COMPLIANCE:

- ASME A112.19.3
- CSA B45.0-02
- CSA B45.4-02

### OPTIONAL ACCESSORIES:

- Grid #200167
- Colander #205010
- Cutting board #210040

### WARRANTY:

Julien inc. offers a LIMITED LIFETIME WARRANTY on the [fix] components of its stainless steel sinks against defects of material and workmanship. For further details on our product warranty, please refer to our catalog or Web site.

### PRODUCT SPECIFICATIONS:

Sink type to be undermount single bowl. Sink to be handcrafted from a single sheet of 16 ga stainless steel having 18/10 chrome/nickel content and a no.4 brushed finish. Sink to feature bowl bottom grooves, center-back Ø3 1/2" drain placement and sound insulation pads. Sink overall dimensions to be 34" left-to-right and 19,5" front to back. Bowl dimensions to be 33" left-to-right and 18" front to back. Sink to feature 29mm radius corners. Sink to be Julien Classic™ collection model no. 3259 with bowl depth of 10".

### PROJECT/JOB INFORMATION:

Project/Job name: \_\_\_\_\_

Specifier: \_\_\_\_\_

Contractor: \_\_\_\_\_



### SINK DIMENSIONS:

Model	Overall	Bowl (s)	Depth	Recommended Cabinet size
3259	34 x 19,5	33 x 18	10	39

- All dimensions are in inches
- Cutout template supplied with every sink and available on our web site

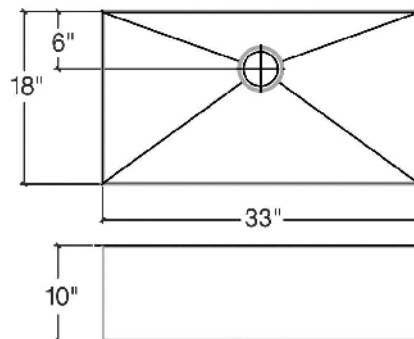

This specification is subject to change without notice. Julien assumes no responsibility for the use of superseded or voided specifications.