

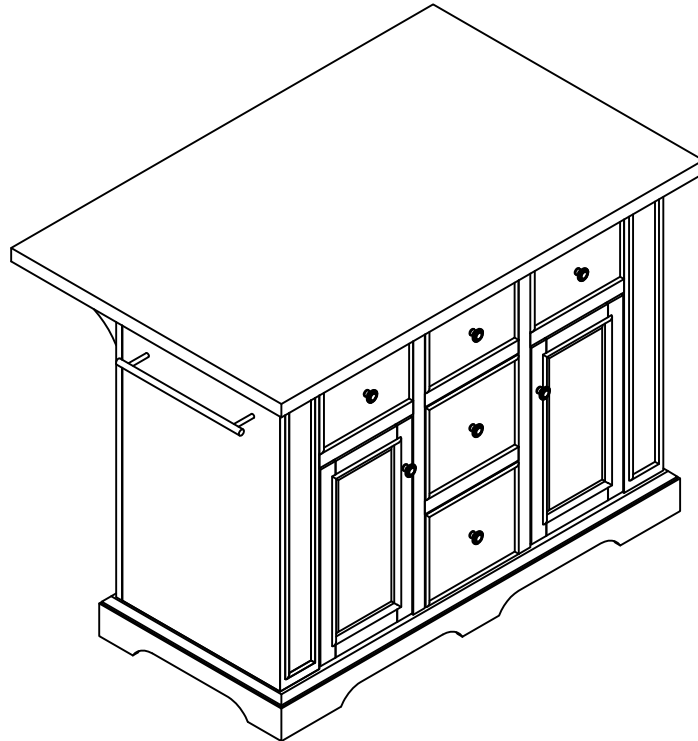

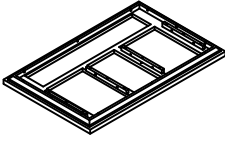

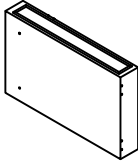

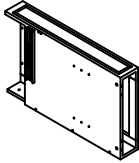
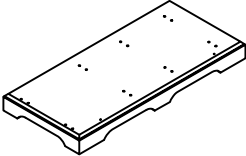
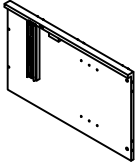
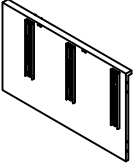
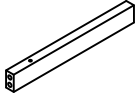
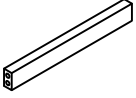
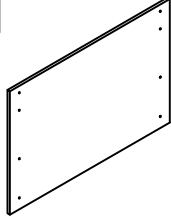
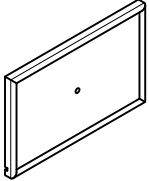
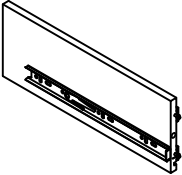
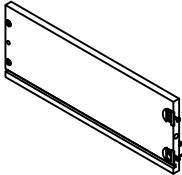
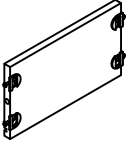
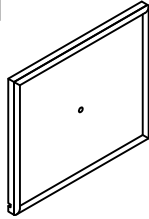
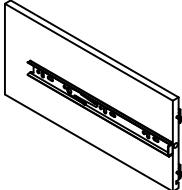
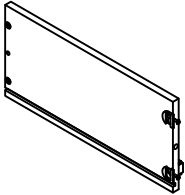
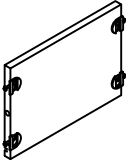
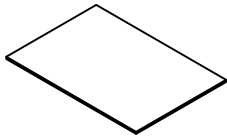
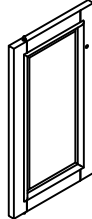
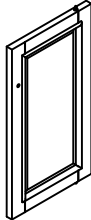
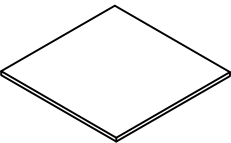
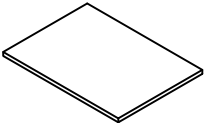

Kitchen Island
CF3025

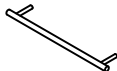

PART LIST

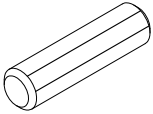
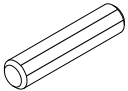
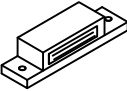
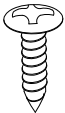
<p>A</p> 	<p>B</p> 	<p>C</p> 	<p>D</p> 	<p>E</p> 
<p>Top Panel 1 PC</p>	<p>Left Panel 1 PC</p>	<p>Right Panel 1 PC</p>	<p>Bottom Panel 1 PC</p>	<p>Left Partition Panel 1 PC</p>
<p>F</p> 	<p>G</p> 	<p>H</p> 	<p>I</p> 	<p>J</p> 
<p>Right Partition Panel 1 PC</p>	<p>Front Rail 2 PCS</p>	<p>Front Middle Rail 2 PCS</p>	<p>Back Panel 1 PC</p>	<p>Small Drawer Front Panel 3 PCS</p>
<p>K</p> 	<p>L</p> 	<p>M</p> 	<p>N</p> 	<p>O</p> 
<p>Small Drawer Left Panel 3 PCS</p>	<p>Small Drawer Right Panel 3 PCS</p>	<p>Small Drawer Back Panel 3 PCS</p>	<p>Large Drawer Front Panel 2 PCS</p>	<p>Large Drawer Left Panel 2 PCS</p>
<p>P</p> 	<p>Q</p> 	<p>R</p> 	<p>S</p> 	<p>T</p> 
<p>Large Drawer Right Panel 2 PCS</p>	<p>Large Drawer Back Panel 2 PCS</p>	<p>Drawer Bottom Panel 5 PCS</p>	<p>Left Door Panel 1 PC</p>	<p>Right Door Panel 1 PC</p>
<p>U</p> 	<p>V</p> 	<p>W</p> 	<p>X</p> 	
<p>Left Adjustable Shelf 1 PC</p>	<p>Right Adjustable Shelf 1 PC</p>	<p>Support Panel 2 PCS</p>	<p>Towel Bar 2 PCS</p>	

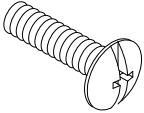
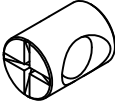
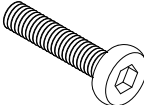
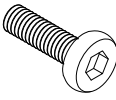
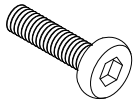
HARDWARE LIST

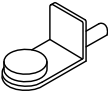
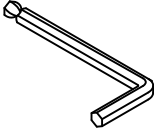
#1  Ø8*30mm	#2  Ø6*30mm	#3 	#4  12*Ø3**D6mm	#5 
Large Wood Dowel 32 PCS (Extra 1)	Small Wood Dowel 20 PCS (Extra 1)	Magnet 2 PCS	Round Head Screw 4 PCS (Extra 1)	Knob 7 PCS
#6  3/4**Ø5/32*D9mm	#7 	#8  2**Ø1/4**D11mm	#9  1**Ø1/4**D11mm	#10  1-1/4**Ø1/4**D11mm
Round Head Bolt 7 PCS (Extra 1)	Barrel Nut 8 PCS	Long Bolt 12 PCS (Extra 1)	Short Bolt 4 PCS (Extra 1)	Bolt 12 PCS (Extra 1)
#11 	#12 	#13 	#14 	
Spring Washer 8 PCS (Extra 1)	Flat Washer 8 PCS (Extra 1)	Shelf Holder 8 PCS	Allen Wrench 1 PC	

ADDITIONAL TOOLS (Not Provided)

Note: It is not recommended to use power tools during assembly.



Phillips Head Screwdriver

Note: Wood dowels are intended for alignment. Additional clearance between wood dowel and pre-drilled hole is intentional for ease of assembly.

Please do not use tools to assemble this unit unless specifically indicated.

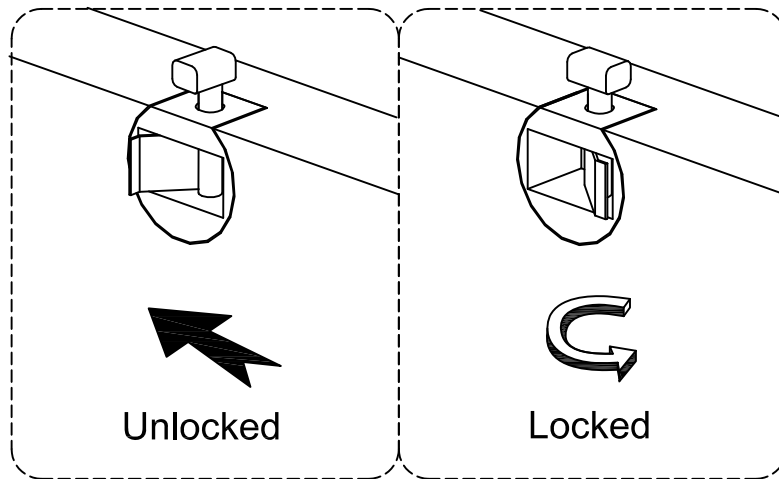

Reference the images above any time the instructions state "lock the hardware".
Note: Be sure to check all hardware is locked when completed.

Step 1. Attach knobs (part #5) to door panels (parts S & T) and drawer front panels (parts J & N) using round head bolts (part #6) and phillips head screwdriver.

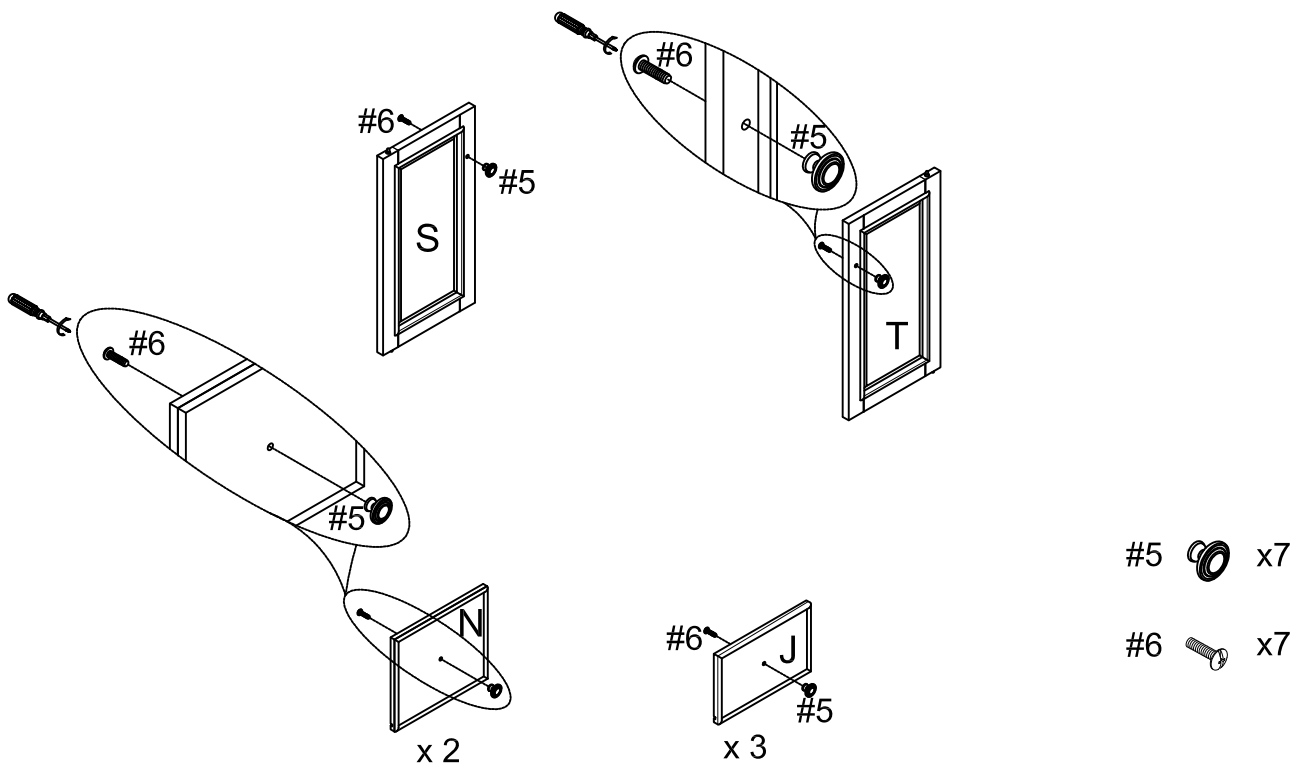

Step 2. Attach magnets (part #3) to partition panels (parts E & F) using round head screws (part #4) and phillips head screwdriver.

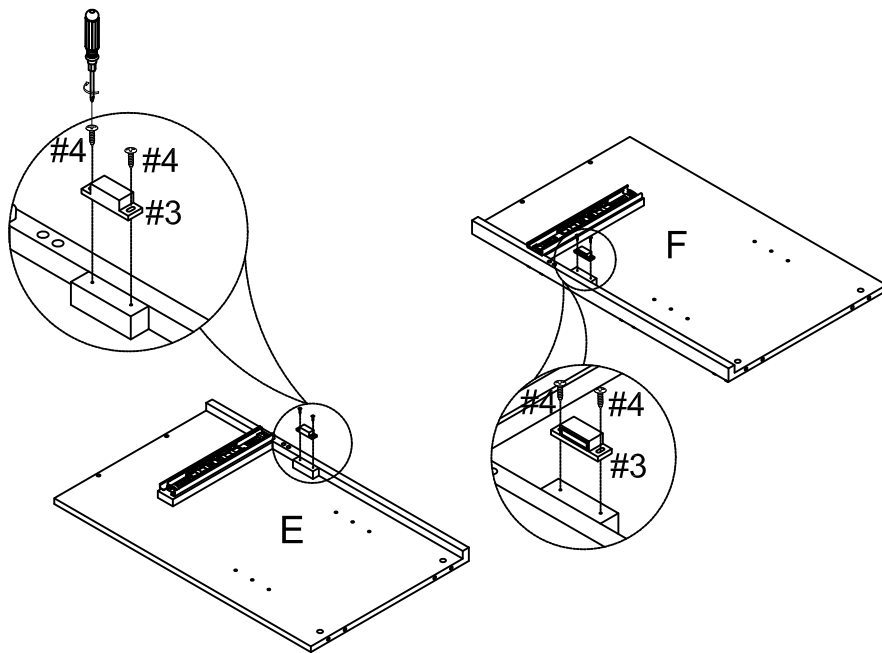

#3  x2

#4  x4

Step 3. Attach small drawer panels (parts K & L) to small drawer back panel (part M) using small wood dowels (part #2) and lock the hardware. Slide drawer bottom panel (part R) into grooves of assembled unit (parts K, L & M). Attach small drawer front panel (part J) to assembled unit (parts K, L & R) using small wood dowels (part #2) and lock the hardware. Repeat for remaining drawers.

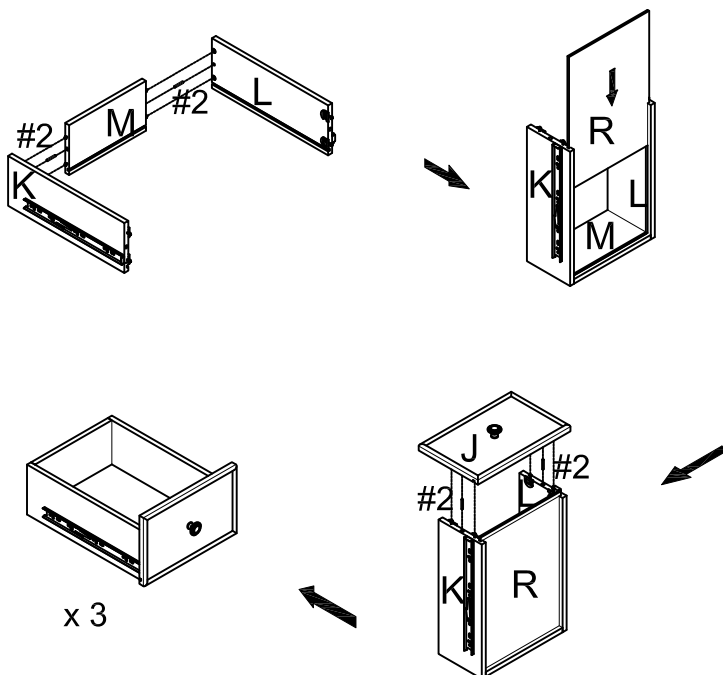

#2  x12