

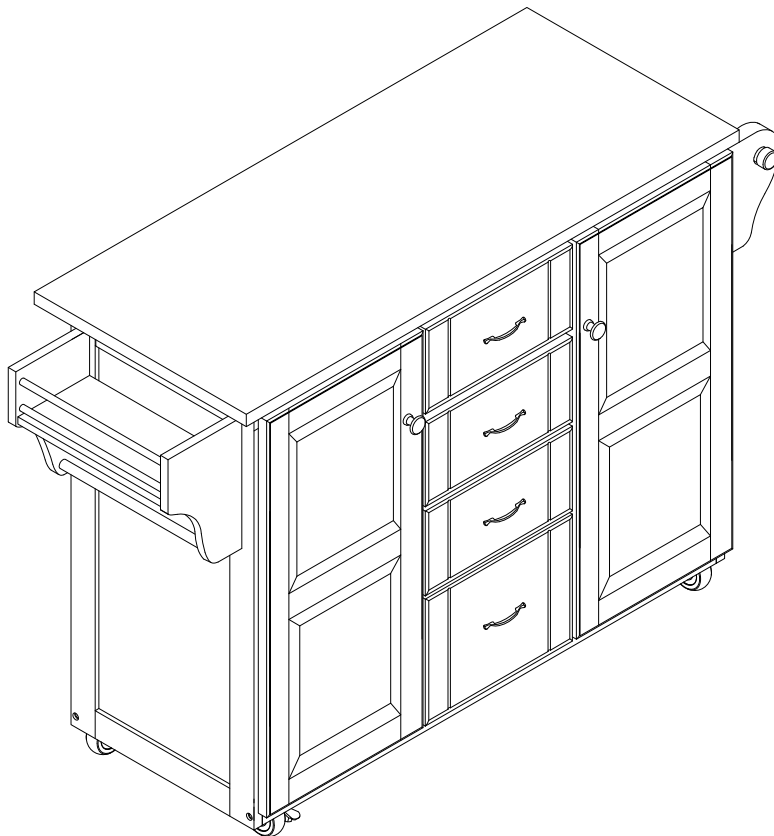

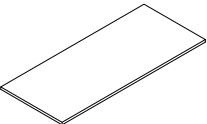

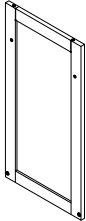

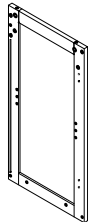

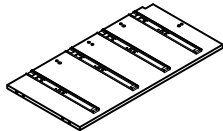
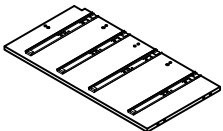
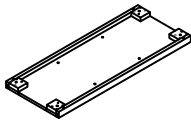
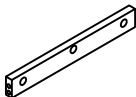
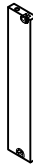

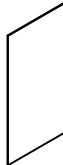
Kitchen Cart
CF3017

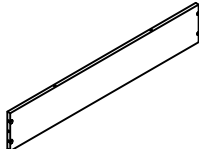
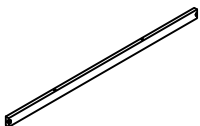
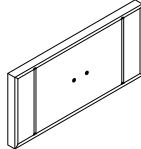
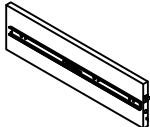
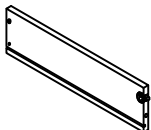
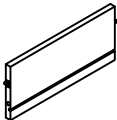
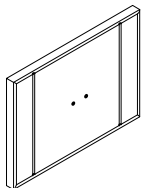
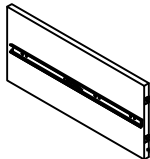
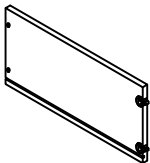
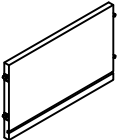
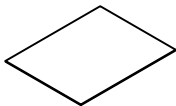
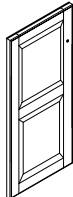
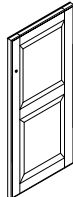
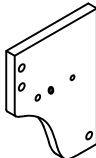



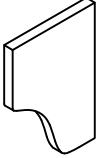
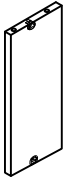
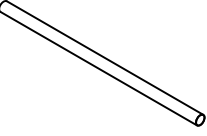
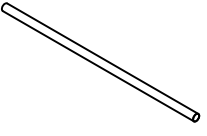

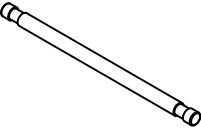
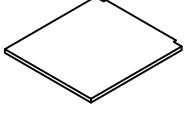

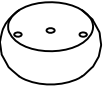



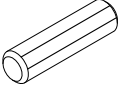
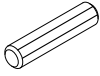

PART LIST

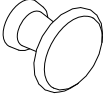
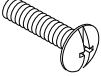
| | | | | |
|---|---|---|---|---|
| A  | B  | C  | D  | E  |
| Top Panel (Ships Separately) 1 PC | Left Side Panel 1 PC | Right Side Panel 1 PC | Left Partition Panel 1 PC | Right Partition Panel 1 PC |
| F  | G  | H  | I  | J  |
| Bottom Panel 1 PC | Top Rail 1 PC | Front Rail 2 PCS | Front Middle Rail 1 PC | Back Panel 3 PCS |
| K  | L  | M  | N  | O  |
| Back Rail 2 PCS | Back Top Rail 1 PC | Front Top Rail 1 PC | Top Drawer Front Panel 3 PCS | Top Drawer Left Side Panel 3 PCS |
| P  | Q  | R  | S  | T  |
| Top Drawer Right Side Panel 3 PCS | Top Drawer Back Panel 3 PCS | Bottom Drawer Front Panel 1 PC | Bottom Drawer Left Side Panel 1 PC | Bottom Drawer Right Side Panel 1 PC |
| U  | V  | W  | X  | Y  |
| Bottom Drawer Back Panel 1 PC | Drawer Bottom Panel 4 PCS | Left Door Panel 1 PC | Right Door Panel 1 PC | Towel Bar Left Side Panel 1 PC |

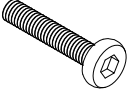
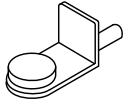
PART LIST

| | | | | |
|--|--|--|--|--|
| Z  | ZA  | ZB  | ZC  | ZD  |
| Towel Bar Right Side Panel 1 PC | Towel Bar Support Panel 1 PC | Large Support Bar 1 PC | Small Support Bar 2 PCS | Small Towel Bar Panel 2 PCS |
| ZE  | ZF  | ZG  | ZH  | ZI  |
| Small Towel Bar 1 PC | Adjustable Shelf 2 PCS | Locking Caster 2 PCS | Caster 2 PCS | Leg 4 PCS |

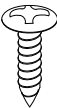
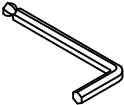
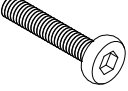
HARDWARE LIST

| | | | | |
|---|--|--|---|---|
|  Ø8*30mm |  Ø6*30mm |  Cam Bolt |  Cam Lock |  Handle |
| Large Wood Dowel 50 PCS (Extra 1) | Small Wood Dowel 12 PCS (Extra 1) | 7 PCS (Extra 1) | 7 PCS (Extra 1) | 4 PCS |
|  Knob |  3/4"*Ø5/32"*D9mm |  Barrel Nut |  1-3/4"*Ø1/4"*D11mm |  Shelf Holder |
| 2 PCS | 10 PCS (Extra 1) | 4 PCS | 14 PCS (Extra 1) | 8 PCS (Extra 1) |
|  Magnet |  12*Ø3*D6mm |  12*Ø3*D6mm |  Door Hinge |  12*Ø4*D9mm |
| 2 PCS | 16 PCS (Extra 1) | 4 PCS (Extra 1) | 4 PCS | 16 PCS (Extra 1) |
|  Allen Wrench |  1-1/2"*Ø5/16"*D13mm |  Flat Washer |  Spring Washer | |
| 1 PC | 4 PCS (Extra 1) | 4 PCS (Extra 1) | 4 PCS (Extra 1) | |

ADDITIONAL TOOLS (Not Provided)

Note: It is not recommended to use power tools during assembly.

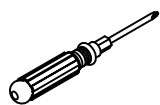

Phillips Head Screwdriver

Please do not use tools to assemble this unit unless specifically indicated.

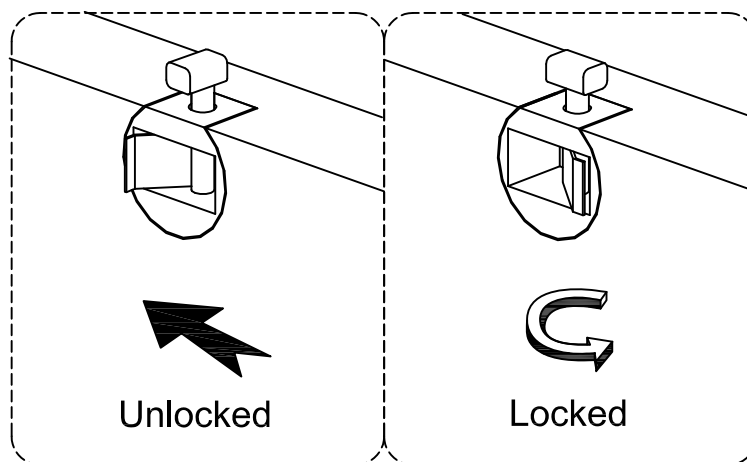

Reference the images above any time the instructions state "lock the hardware".
Note: Be sure to check all hardware is locked when completed.

Note: Wood dowels are intended for alignment. Additional clearance between wood dowel and pre-drilled hole is intentional for ease of assembly.

Step 1. Attach handles (part #5) to top drawer front panel (part N) and bottom drawer front panel (part R) using round head bolts (part #7) and phillips head screwdriver. Attach knobs (part #6) to left door panel (part W) and right door panel (part X) using round head bolts (part #7) and phillips head screwdriver.

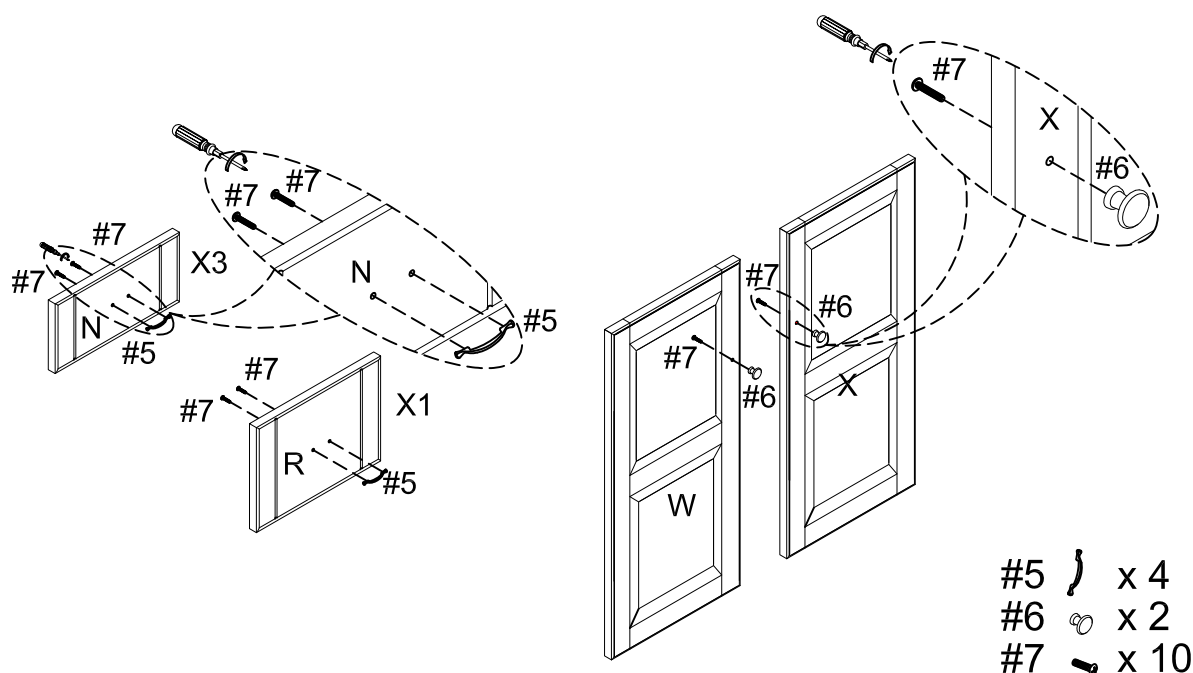

Step 2. Attach door hinges (part #14) to left door panel (part W) and right door panel (part X) using small round head screws (part #12) and phillips head screwdriver.

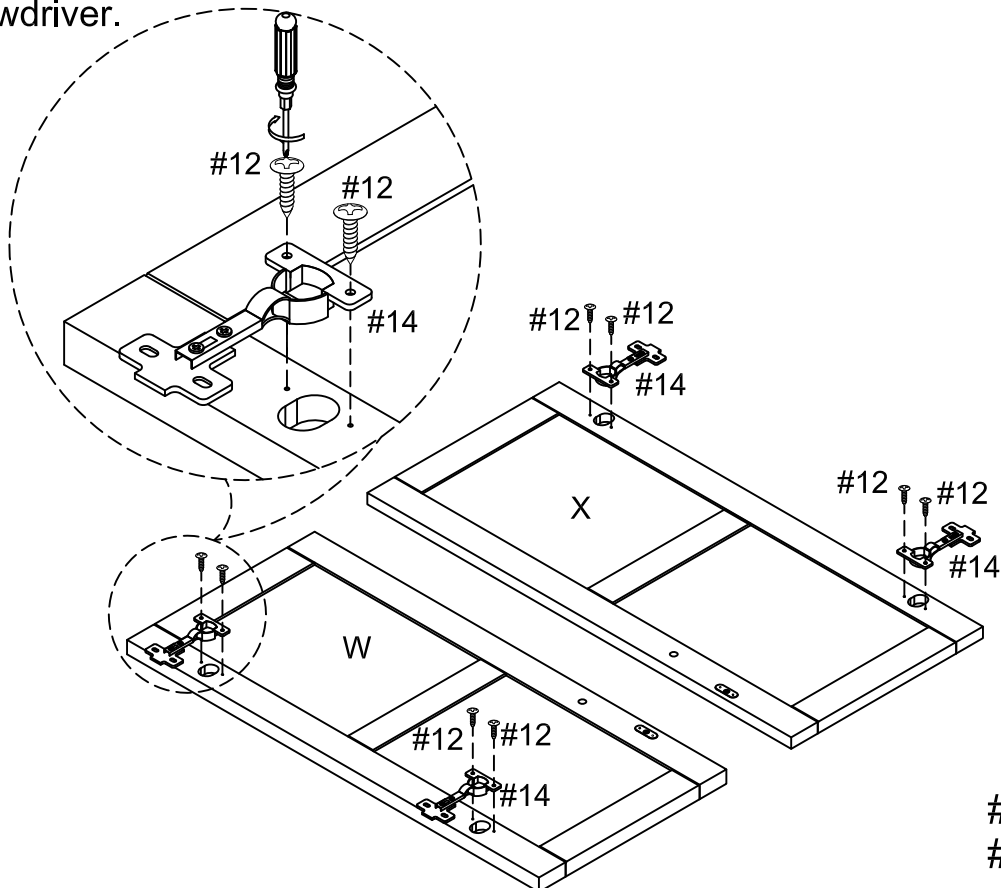



- #12  x 8
- #14  x 4

Step 3. Attach magnets (part #11) to left partition panel (part D) and right partition panel (part E) using black screws (part #13) and phillips head screwdriver. Insert cam bolts (part #3) to top panel (part A), left partition panel (part D) and right partition panel (part E) using phillips head screwdriver.

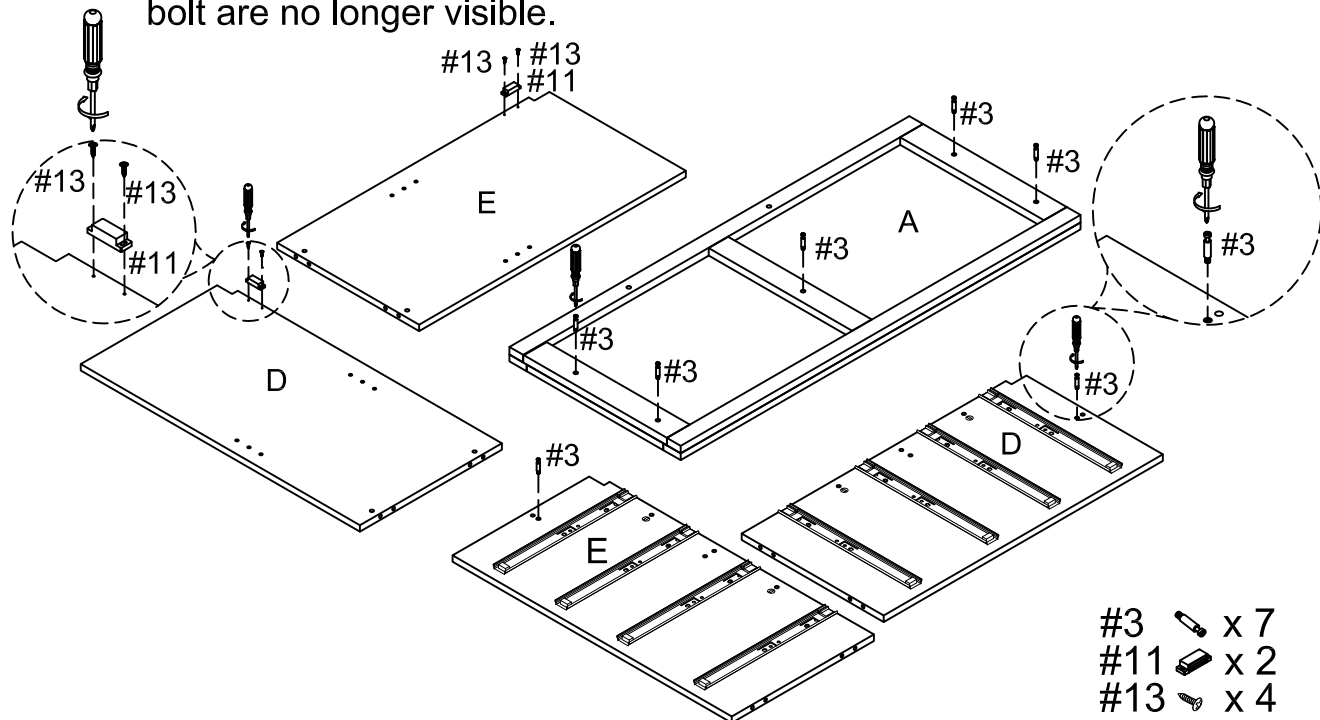
NOTE: Do not overtighten cam bolts. Stop tightening once threads on cam bolt are no longer visible.



- #3  x 7
- #11  x 2
- #13  x 4

Step 4. Attach top drawer left side panel (part O) and top drawer right side panel (part P) to top drawer back panel (part Q) using small wood dowels (part #2) and lock the hardware. Slide drawer bottom panel (part V) into grooves of assembled unit (parts O, P & Q). Attach top drawer front panel (part N) to assembled unit (parts O, P & V) using small wood dowels (part #2) and lock the hardware. Repeat for remaining drawers.

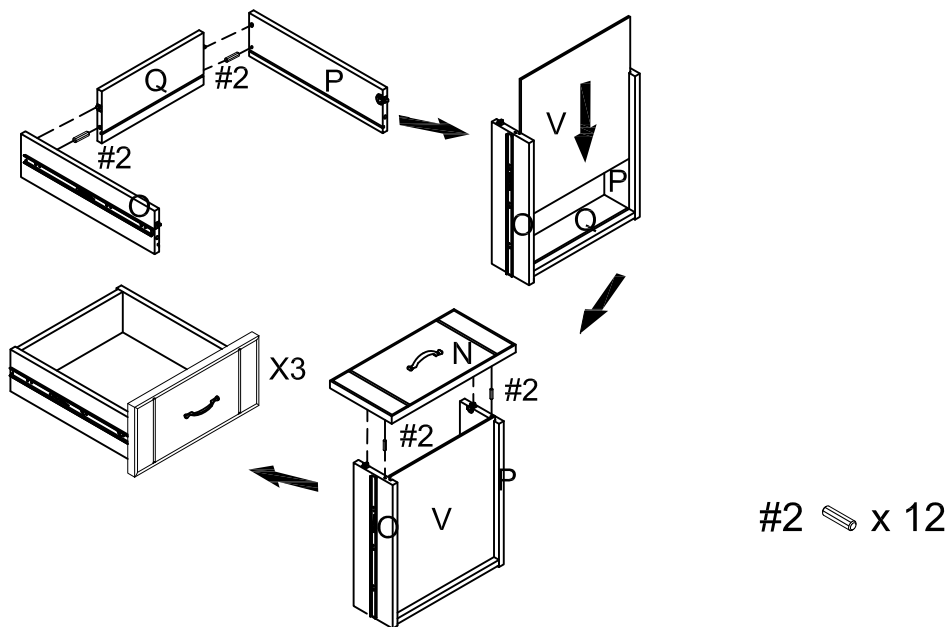

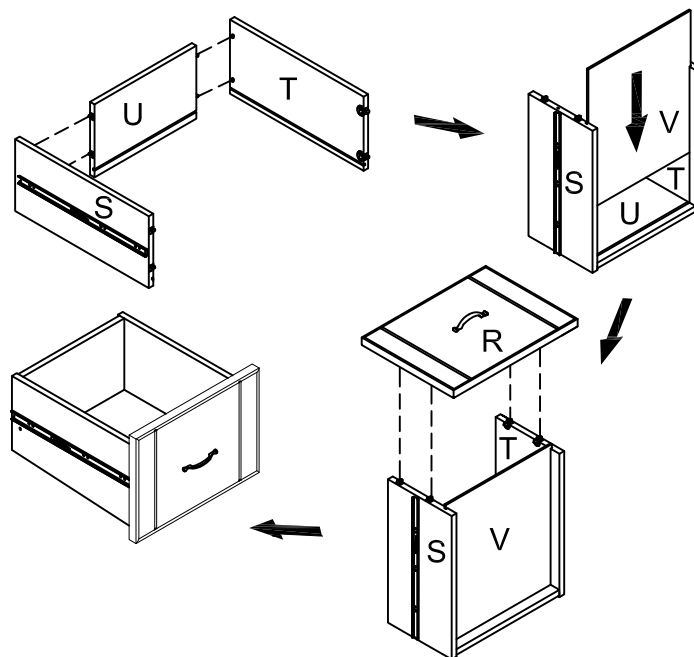

Step 5. Attach bottom drawer left side panel (part S) and bottom drawer right side panel (part T) to bottom drawer back panel (part U) and lock the hardware. Slide drawer bottom panel (part V) into grooves of assembled unit (parts S, T, & U). Attach bottom drawer front panel (part R) to assembled unit (parts S, T, & V) and lock the hardware.

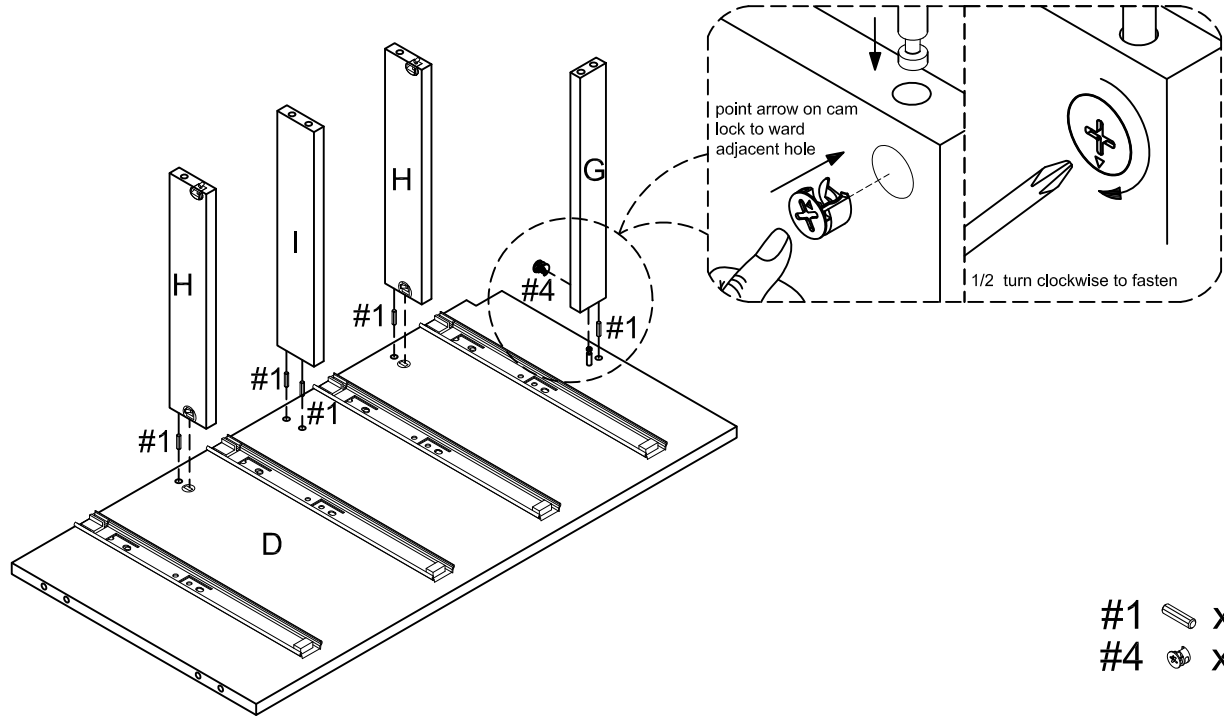

Step 6. Attach top rail (part G), front rails (part H) and front middle rail (part I) to left partition panel (part D) using large wood dowels (part #1), cam lock (part #4) and lock the hardware.

NOTE: Cam locks must rotate a full 180°. See pictured insert.





- #1  x 5
- #4  x 1

Step 7. Attach top rail (part G), front rails (part H) and front middle rail (part I) to right partition panel (part E) using large wood dowels (part #1), cam lock (part #4) and lock the hardware.

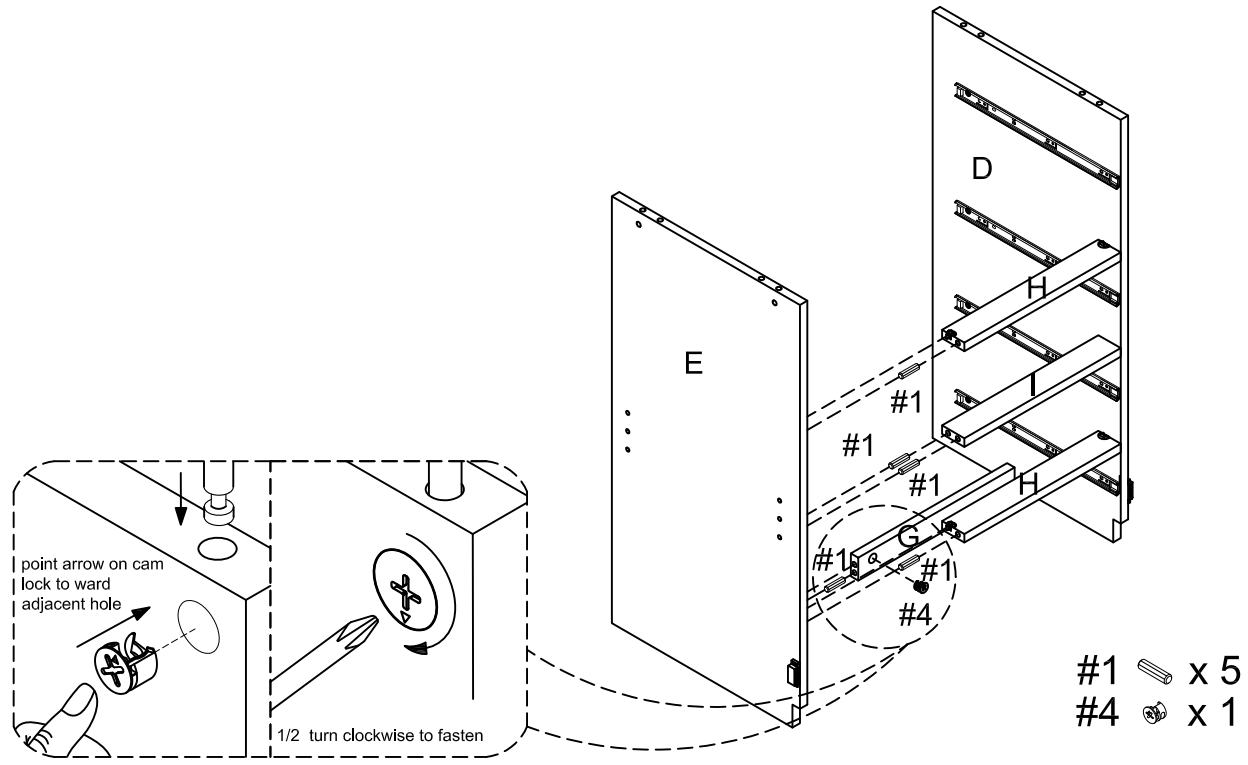
NOTE: Cam locks must rotate a full 180°. See pictured insert.



- #1  x 5
- #4  x 1