

BEFORE YOU BEGIN YOUR INSTALLATION



Shut off water supply



Flush hot and cold water supply lines



Required tools



Installation by License Professional Plumber



Flush the water pipe before installation



Drawings are for reference only



Do not disassemble the body

FAUCET INSTALLATION

1

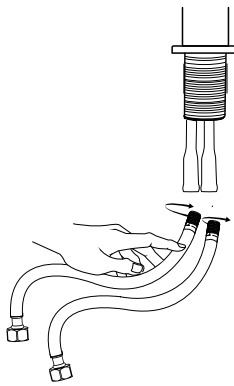

Connect the braided supply hoses to the faucet, hand tight firmly.

2

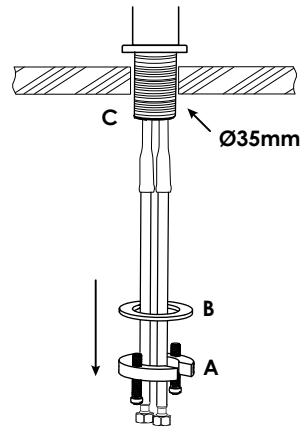

Ensure there is a Ø35mm through-hole on the kitchen counter. Remove the mounting nut (A) and washer (B) from the threaded shroud (C).

3

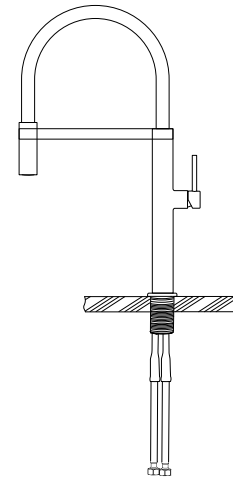

Position faucet on the installation surface. Fit flexible hoses through hole on countertop or sink.

4

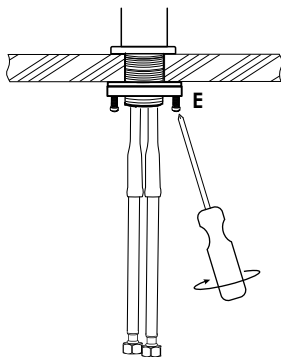

Slide washer and thread the mounting nut onto threaded shroud. Turn faucet to desired handle position. Securely tighten clamp screws (E)

5

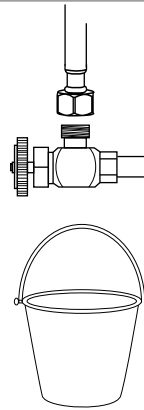

Before connecting supply hose, flush supply valves to clear any debris. Place a bucket underneath valves and run water for 5 to 10 seconds. Turn water off.

6

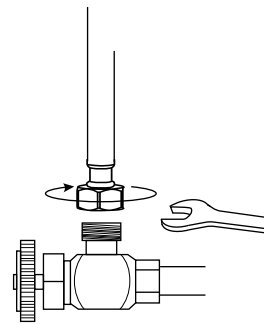

Connect hot and cold water lines to the inlet pipe and tighten with a wrench until snug. Do not over tight.

CARE AND CLEANING

Clean the faucet frequently using mild soap or an on-abrasive cleaner and then quickly rinse with water and dry with soft cloth only.

Using abrasive cleaners, solvents, acid cleaners or any scrubbing detergent, polisher or scraper will damage the finish and void the warranty.

AVANT DE COMMENCER VOTRE INSTALLATION



Coupez l'alimentation en eau



Videz les conduites d'eau chaude et froide



Outils nécessaires



Installation par un plombier professionnel accrédité



Videz la conduite d'eau avant l'installation



Les illustrations ne sont données qu'à titre indicatif



Ne pas démonter le boîtier

INSTALLATION DU ROBINET

1

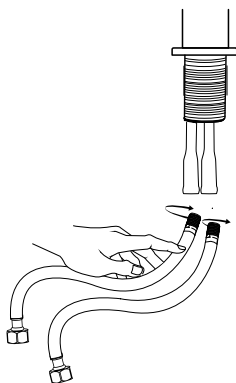

Raccordez les tuyaux d'alimentation tressés au robinet et main bien serrée.

2

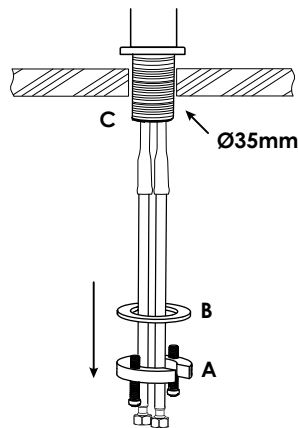

Ensure there is a Ø35mm through-hole on the kitchen counter. Remove the mounting nut (A) and washer (B) from the threaded shroud (C).

3

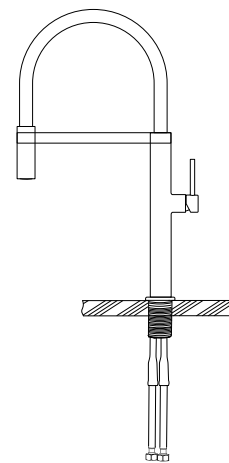

Placez le robinet sur la surface d'installation. Installez les tuyaux flexibles dans le trou du comptoir ou de l'évier.

4

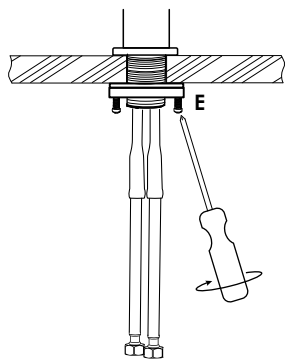

Faites glisser la rondelle et vissez l'écrou de montage sur l'enveloppe fileté. Tournez le robinet vers la position désirée. Serrez fermement la poignée. Serrez fermement les vis de serrage (E).

5

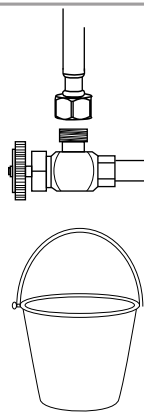

Avant de brancher le tuyau d'alimentation, rincez les vannes d'alimentation pour éliminer tout débris. Placez un seau sous les vannes et faites couler l'eau pendant 5 à 10 secondes.

6

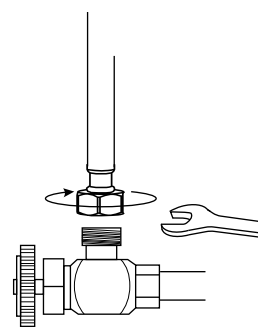

Raccordez les conduites d'eau chaude et froide au tuyau d'entrée et serrez-les bien à l'aide d'une clé. Ne pas trop serrer.

ENTRETIEN ET NETTOYAGE

Nettoyez fréquemment le robinet à l'aide d'un savon doux ou d'un nettoyant non abrasif, puis rincez-le rapidement à l'eau et séchez-le avec un chiffon doux.

L'utilisation de nettoyants abrasifs, de solvants, de nettoyants acides ou de tout autre détergent à récurer, polisseur ou grattoir endommagera la finition et annulera la garantie.