

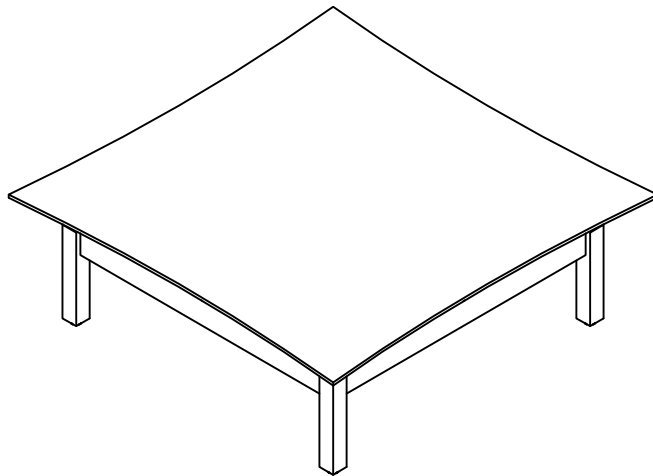







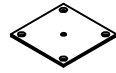

**Sterling Series™
Coffee Table**

Model No. STCT

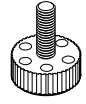

ASSEMBLY INSTRUCTIONS

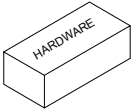
PARTS LIST

Name	Part	Qty.	Spare Qty	Name	Part	Qty.	Spare Qty
A	 REALS611 Mounting Plate	4		F	 REALS617** Cam Sticker	20	1
B	 REALS206 M6x15mm	20	1	G	 REALS607 Ø32mm Base Stand-off	4	
C	 REALS425 Leveler	4		H	 REALS613 Ø20mm Base Stand-off	4	
D	 REALS003 Cam Post	20	1		 STCTHB		
E	 REALS001 Cam Lock	20	1				

Items with HB are in hardware box.

PARTS LIST

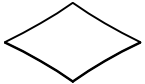
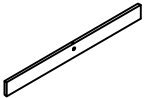
Name	Part	Qty.
I	 STCT** Top	1
J	 STCTJ** Modesty Panel	4

Name	Part	Qty.
K	 STCTK** Leg	4

**Denotes Color Code

2

IMPORTANT!

Review ALL instructions before beginning assembly. These instructions are provided to avoid problems that may occur from improper assembly or installation. Mayline and/or its distributor are not responsible for failure resulting from improper assembly or installation of this product. Moreover, all warranties are void for failure to follow these assembly instructions.

- 1** Insert Cam Post (D) into Leg (K). Install Cam (E) Modesty Panel (J). Attach Modesty Panel (J) to assembled coffee table Base by turning Cams (E). Apply Cam Stickers (F) to Cams (E) of Modesty Panel (J). Install Levelers (C) into threaded inserts in underside of Leg (K).

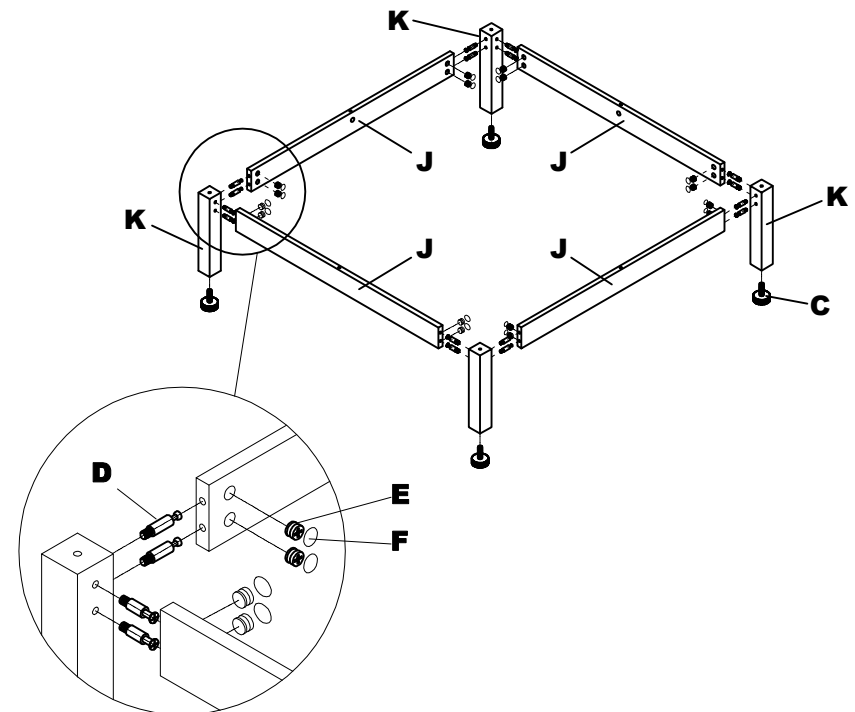

3

- 2** Install Base Stand-off (G) into threaded inserts in upperside of Leg (J). Install Mounting Plate(A) into Base Stand-off (G) by using Screws (B).

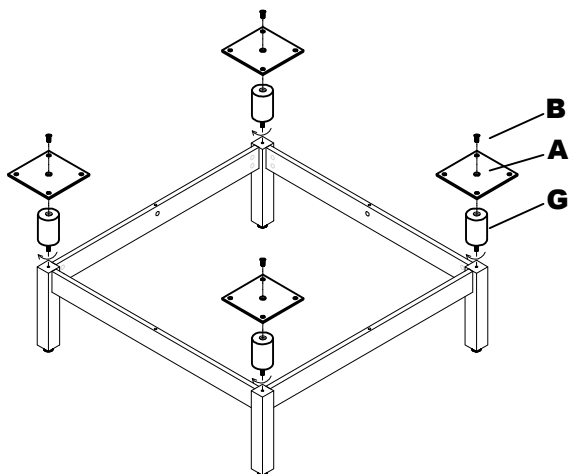

- 3** Install Base Stand-off (H) into the Bottom of Top (I). Insert Cam Post (D) into Base Stand-off (H).

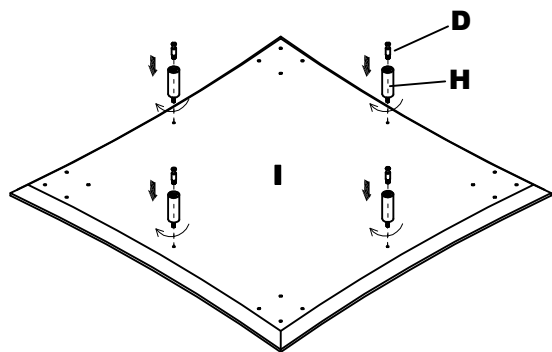

4

- 4** Install the Mounting Plate(A) to the underside of Top (I) using Screws (B). Install Cams (E) modesty Panel (J). Apply Cam Stickers (F) to Cams (E) of Modesty Panel (J).

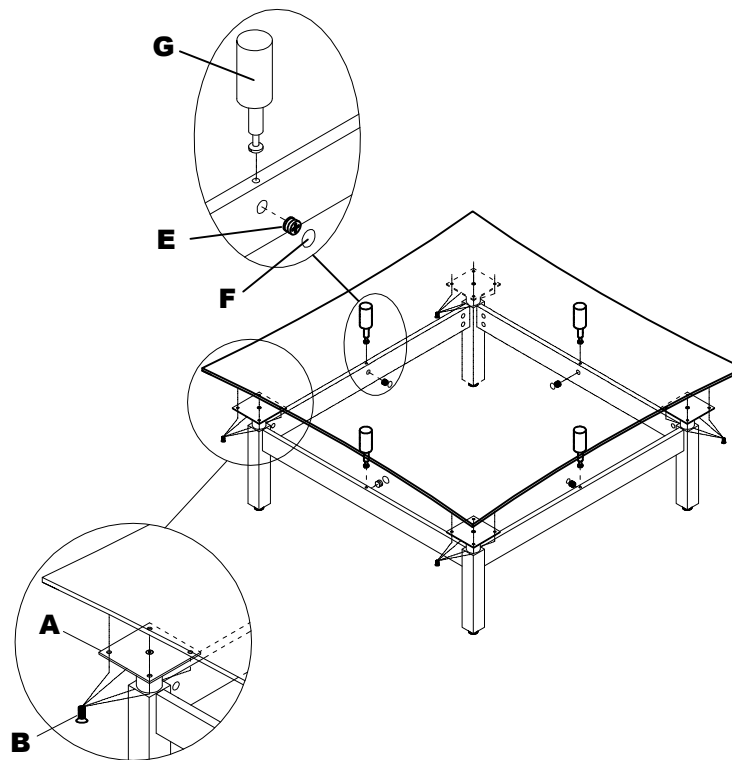

5