

# French Countryside Dining Table

## IMPORTANT NOTE

Carefully remove all the parts from the carton and put them individually on a soft cloth to prevent scratches or other damages occurring to the parts.

We have taken great care in the design of this product and request that you carefully and strictly follow our assembly instructions to ensure a completed product as it was designed.

*Home Styles*

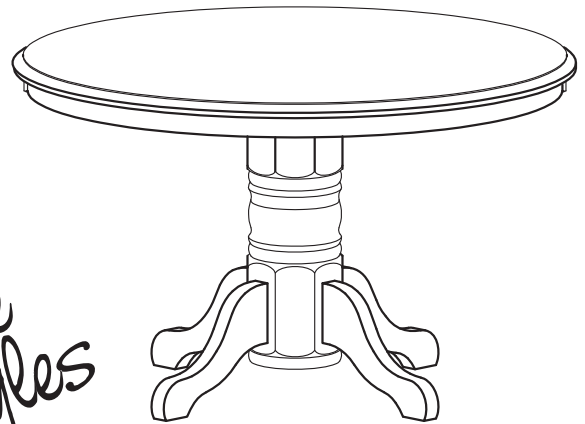

## PART LIST

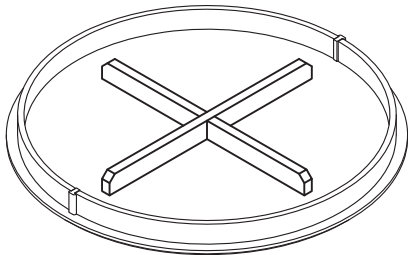

**A.**  
**Table Top**  
 1 pc.

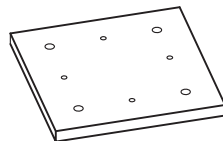

**B.**  
**Connector Panel**  
 1 pc.

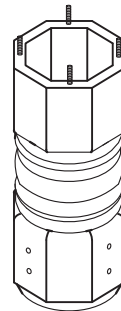

**C.**  
**Post**  
 1 pc.



**D.**  
**Leg**  
 4 pcs.

## HARDWARE LIST



**Key Wrench**  
 1 pc.

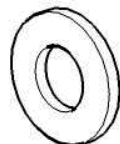

**Flat Washer**  
 16 pcs. (+ 1 extra)



**Nut**  
 12 pcs. (+1 extra)



**Hex Wrench**  
 1 pc.



**Small Hex Wrench**  
 1 pc.



**Spring Washer**  
 16 pcs. (+1 extra)

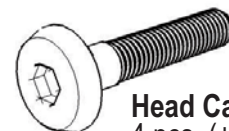

**Head Cap Bolt**  
 4 pcs. (+1 extra)

# Assembly Instructions

## IMPORTANT

- \* You should keep Hex Wrench in a safe place as you may need to tighten up the Head Cap Bolts in the future.
- \* After assembly item must be level to work properly. Use the included adjustable levelers to level.

## STEP 1

Attach Connect Panel (B) to Post (C), using Flat Washers, Spring Washers and Nuts.

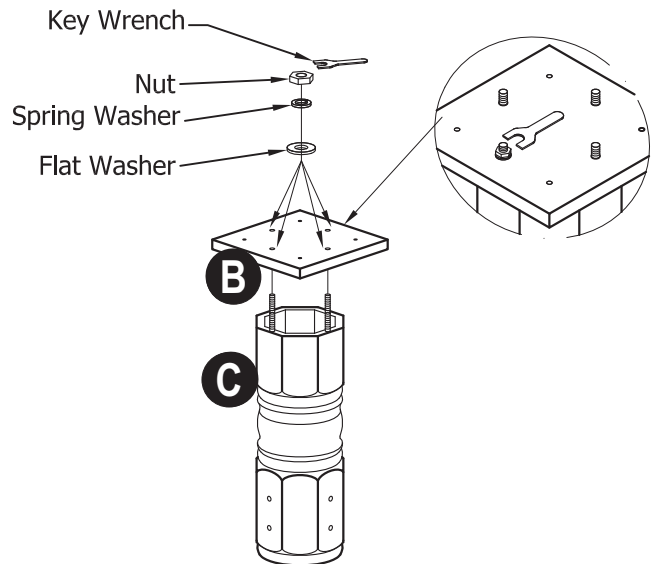
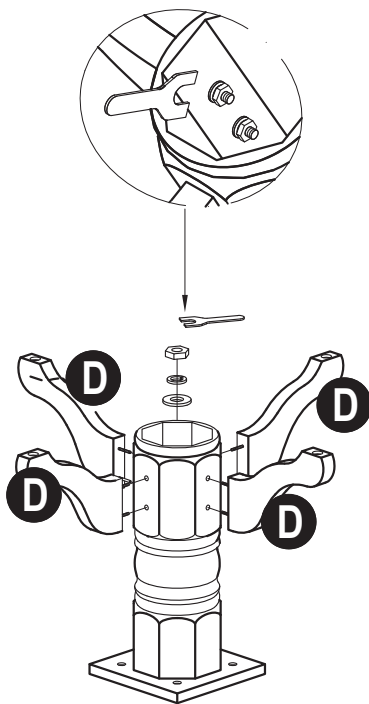

## STEP 2

Turn the unit upside down on the soft cloth.

Attach Table Leg (D) to the unit, using Flat Washers, Spring Washers and Nuts.

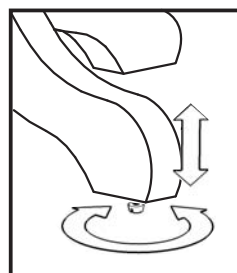

(Figure 1)

## STEP 3

Place the Base Unit in Step 2 on to Table Top (A) with Flat Washers, Spring Washers and Head Cap Bolts.

Turn the assembled unit to it's upright position.

To level the unit, adjust the adjustable levelers on the bottom of unit. (see Figure 1)

