

# Dining Table

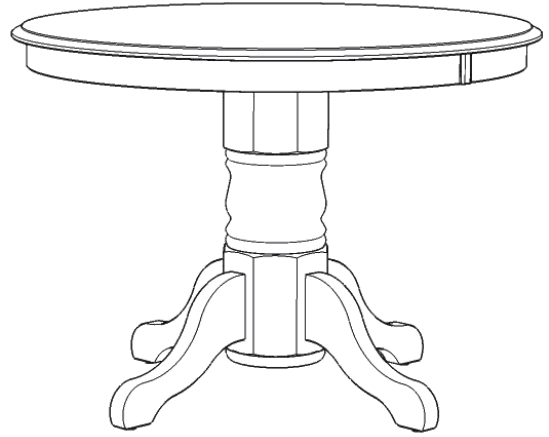

## IMPORTANT

Carefully remove all the parts from the carton and place them individually on a soft cloth to prevent scratches or other damage.

Carefully and strictly follow these assembly instructions to ensure a completed product as designed.

Do not use power tools above 8 volts to assemble.

## Part List

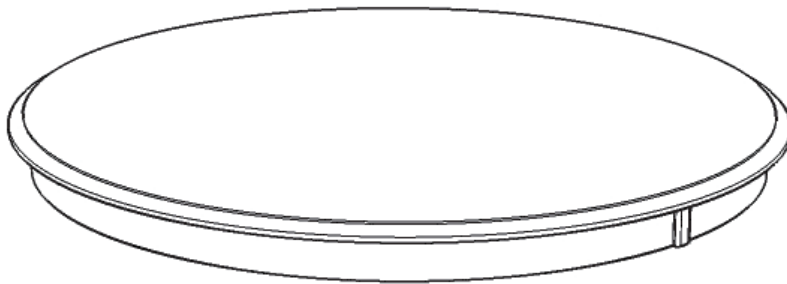

A.  
Top  
1 pc.



B.  
Panel  
1 pc.

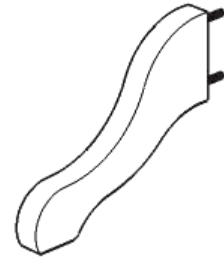

D.  
Leg  
4 pcs.

## Hardware List



Key Wrench  
1 pc.



Hex Wrench  
1 pc.



Small Hex Wrench  
1 pc.



Nut  
12 pcs. (+1 extra)

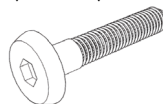

M6x40  
Head Cap Bolt  
4 pcs. (+1 extra)



Spring Washer (large)  
12 pcs. (+1 extra)



Spring Washer (small)  
4 pcs. (+1 extra)

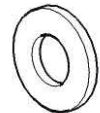

Flat Washer (large)  
12 pcs. (+1 extra)



Flat Washer (small)  
4 pcs. (+1 extra)

Carton 20 05525 0301 is also needed for assembly.

Tool(s) required for assembly: Level

## Assembly Instructions 2/3

### IMPORTANT

- Use a soft cloth between these parts and the floor.
- Do not use power tools above 8 volts to assemble.
- Do not tighten all the bolts until each part is properly assembled.
- The unit must be level to work properly. Use the included adjustable levelers to level.
- Keep Key Wrench and Hex Wrench as the bolts may need to be tightened in the future.

### STEP 1

Attach Panel (B) to Pedestal (C) with Flat Washers (large), Spring Washers (large) and Nuts. (See Figure 1)

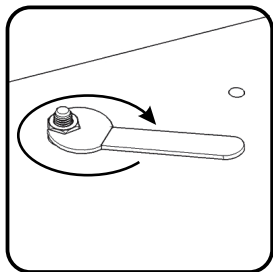

Figure 1

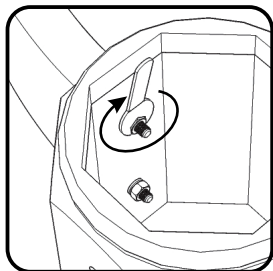
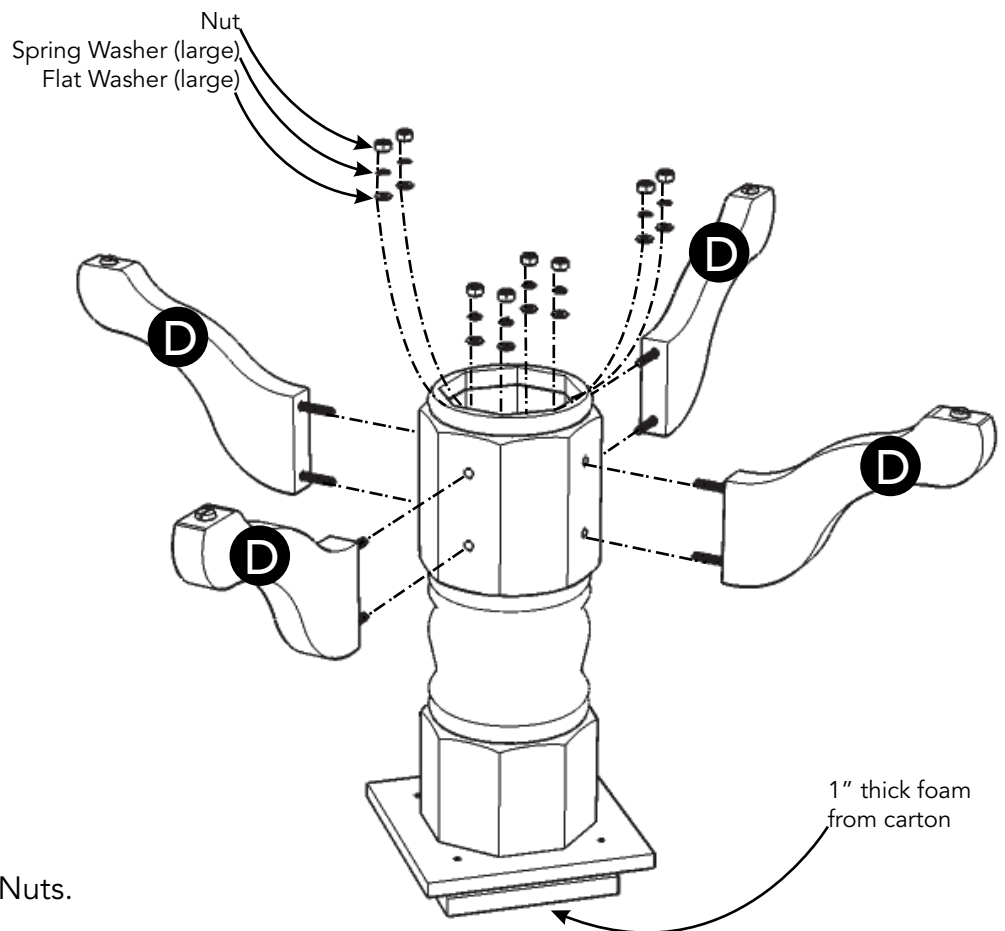
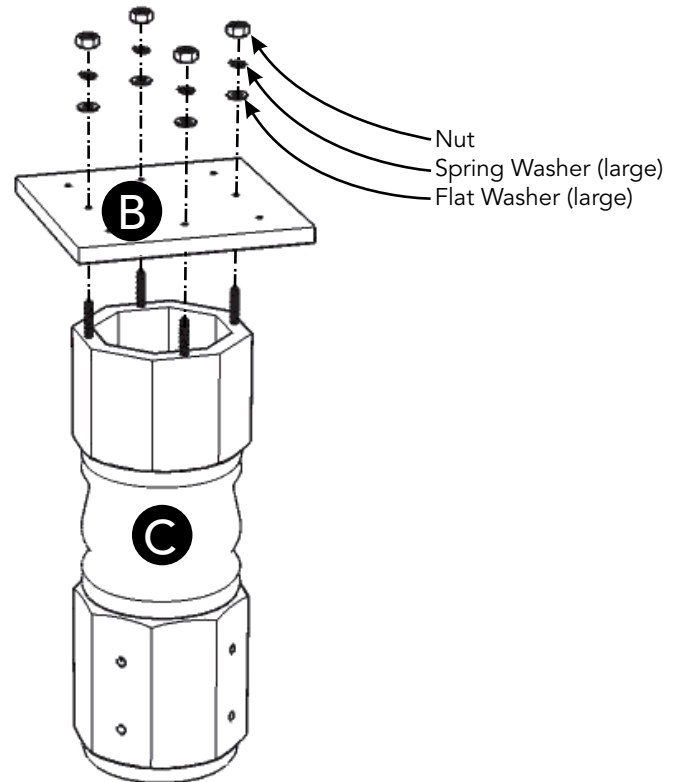

Figure 2

### STEP 2

Place unit upside down on 1" thick foam from carton.

Attach Legs (D) to unit with Flat Washers (large), Spring Washers (large) and Nuts. (See Figure 2)



## Assembly Instructions 3/3

### STEP 3

Place Top (A) upside down on a soft cloth.

Attach unit to Top (A) with Flat Washers (small), Spring Washers (small) and Head Cap Bolts. (See Figure 3)

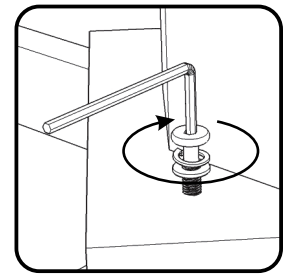
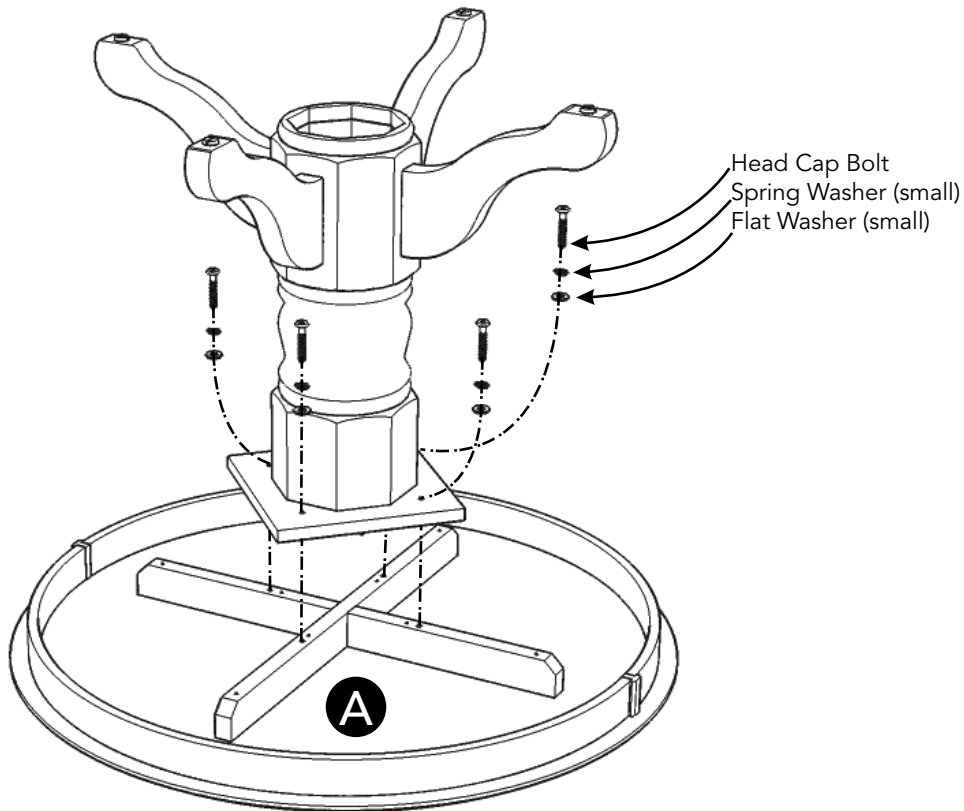

Figure 3

### STEP 4

Turn unit over to its upright position.

Level unit by adjusting the adjustable levelers on bottom of unit.

(See Figure 4)

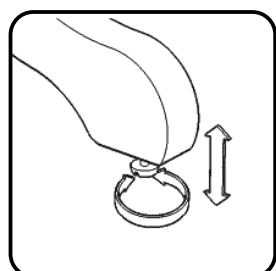
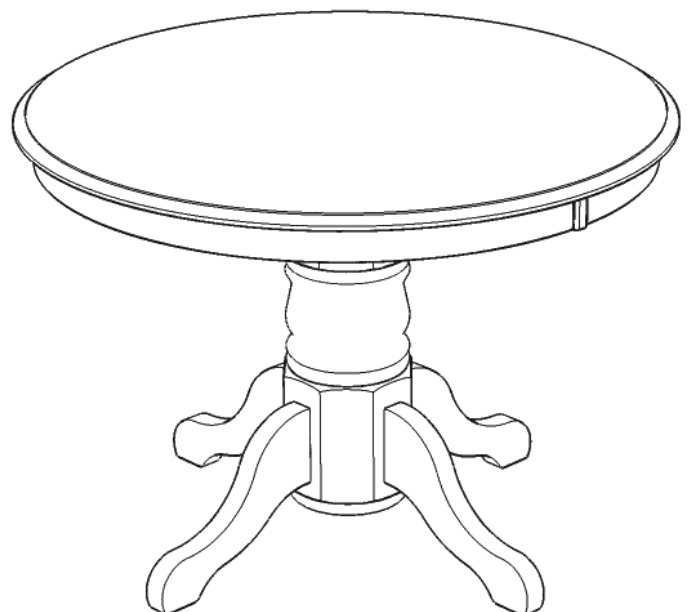

Figure 4



# CARE INSTRUCTIONS

## NEVER

allow liquids to remain on furniture.  
Absorption causes parts to warp  
and split and finishes to delaminate.

## NEVER

use glass cleaners on  
finished furniture. Ammonia  
chemically attacks the finish.



Do not use power tools  
above 8 volts to assemble.  
**PREVENT  
CRACKING**



Do not place  
in direct sunlight.  
**PREVENT  
FADING**



Do not write  
directly on surface.  
**PREVENT  
MARKING**



Do not place hot  
objects on surface.  
**PREVENT  
FINISH DAMAGE**

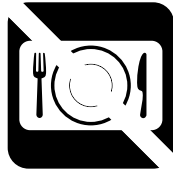

Do not use rubber  
based placemats.  
**PREVENT  
DISCOLORING**



Do not use commercial  
waxes and polishes.  
**PREVENT  
YELLOWING**

## CLEAN

with a soft cloth moistened  
in lukewarm soap and water.  
Buff with a dry clean cloth.

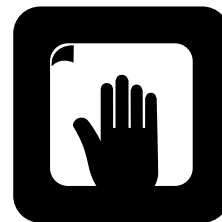

Home Styles will provide replacements free of charge for missing or damaged hardware or parts within 30 days of purchase. Digital images of the defective parts may be required. If the product was not purchased from an authorized retail affiliate, Home Styles is under no obligation to provide replacement parts. Parts are not available for fully assembled items nor are parts available for sale. Replacements for missing or damaged hardware or parts may be requested at: