

BROAN®

BROAN ERV100 PLUS

Part no. ERV100SP

Low speed: 50 CFM (0.2 in. w.g.), selectable 65 CFM

High speed: 100 CFM (0.4 in. w.g.), selectable 85 CFM



V80243

CONSTRUCTION

- 22 ga. galvanized steel housing
- 22 ga. pre-painted steel door
- One-piece molded insulation shell, (expanded polystyrene; UL 94 HF-1 certified)
- Galvanized steel 5" diameter ports*
- Steel door hinges and latches
- Cold side ports with plastic ring; allow vapor barrier sealing
- No drain required
- Included installation brackets

*All units ports were created to be connected to ducts having a minimum of 5" diameter, but if need be, they can be connected to bigger sized ducts by using an appropriate transition (e.g.: 5" diameter to 6" diameter transition).

MOTORS

- Two high reliability, external rotor PSC motors, totally enclosed and thermally protected
- Backward blowers, can support high static pressure environment

FILTERS

- Two washable 20 ppi reticulated polyester urethane foam filters, UL 900 class 2 certified
- Optional MERV 8 filter kit, part no. V21030 (additional 0.1 in. w.g. static pressure to be considered) (sold separately)

ERV CORE

- Crossflow aluminum-polymerized paper core, UL723 certified
- Hydroscopic polymer exchange water by direct vapor transfer using molecular transport without the need of condensation
- Constructed of alternate layers of corrugated aluminum material and polymeric bactericide dessiccant impregnated media; will not promote growth of mold or bacteria
- Unique rectangular flute design to provide very low pressure drop values

This product earned the ENERGY STAR® by meeting strict energy efficiency guidelines set by Natural Resources Canada and the US EPA. It meets ENERGY STAR requirements only when used in Canada.

ENERGY RECOVERY VENTILATOR

Controls

- For a complete list of optional main and auxiliary controls available, refer to the **Wall Control Compatibility Chart** on last pages of wall controls specification sheet, available at www.broan.com.
- For more details about controls, refer to the **Main and auxiliary wall controls** user guide, also available at www.broan.com.
- Removable terminal block included for quicker low voltage control connections
- LED indicator shows error codes
- Unit must be permanently energized, no control should be installed on power supply of unit

Air Flow

- Pressure taps and balancing chart to allow easier balancing of the unit
- Integrated balancing dampers in cold supply and cold exhaust ports
- Integrated motorized damper adjacent to the cold supply port
- Integrated backdraft damper in cold exhaust port

Defrosting System

- Equipped with Homeshield™ defrosting system: recirculation defrost cycle to maintain balanced air pressure in the dwelling unit
- A switch on ERV unit allows 3 quick-access defrost modes, a LED shows which defrost mode has been chosen:
 - Standard (factory set regular mode)
 - Plus (extended defrost for colder areas)
 - Discretion (keeps the same speed when performing defrost as performing ventilation)

DEFROST CYCLES				
OUTDOOR TEMPERATURE*		DEFROST IN MINUTES / AIR EXCHANGE IN MINUTES		
°C	°F	STANDARD	PLUS	DISCRETION
WARMER THAN -10	WARMER THAN 14	NO DEFROST	NO DEFROST	NO DEFROST
FROM -10 TO -15	FROM 14 TO 5	8/50	10/30	16/50
FROM -15 TO -27	FROM 5 TO -17	8/25	10/20	16/25
-27 AND LESS	-17 AND LESS	10/22	10/15	20/22

* Outdoor temperature is read by a thermistor located inside the unit, next to fresh air from outdoor port.

Warranty

The Broan ERV100 PLUS is protected by a 5-year warranty on parts only, with the original proof of purchase.

Requirements and standards

- HVI certified
- ENERGY STAR® qualified
- Complies with the UL 1812 requirements regulating the installation of Energy Recovery Ventilators
- Complies with the CSA C22.2 no. 113 Standard applicable to ventilators
- Complies with CSA C444 requirements regulating the installation of Energy Recovery Ventilators



ENERGY STAR

BROAN ERV100 PLUS

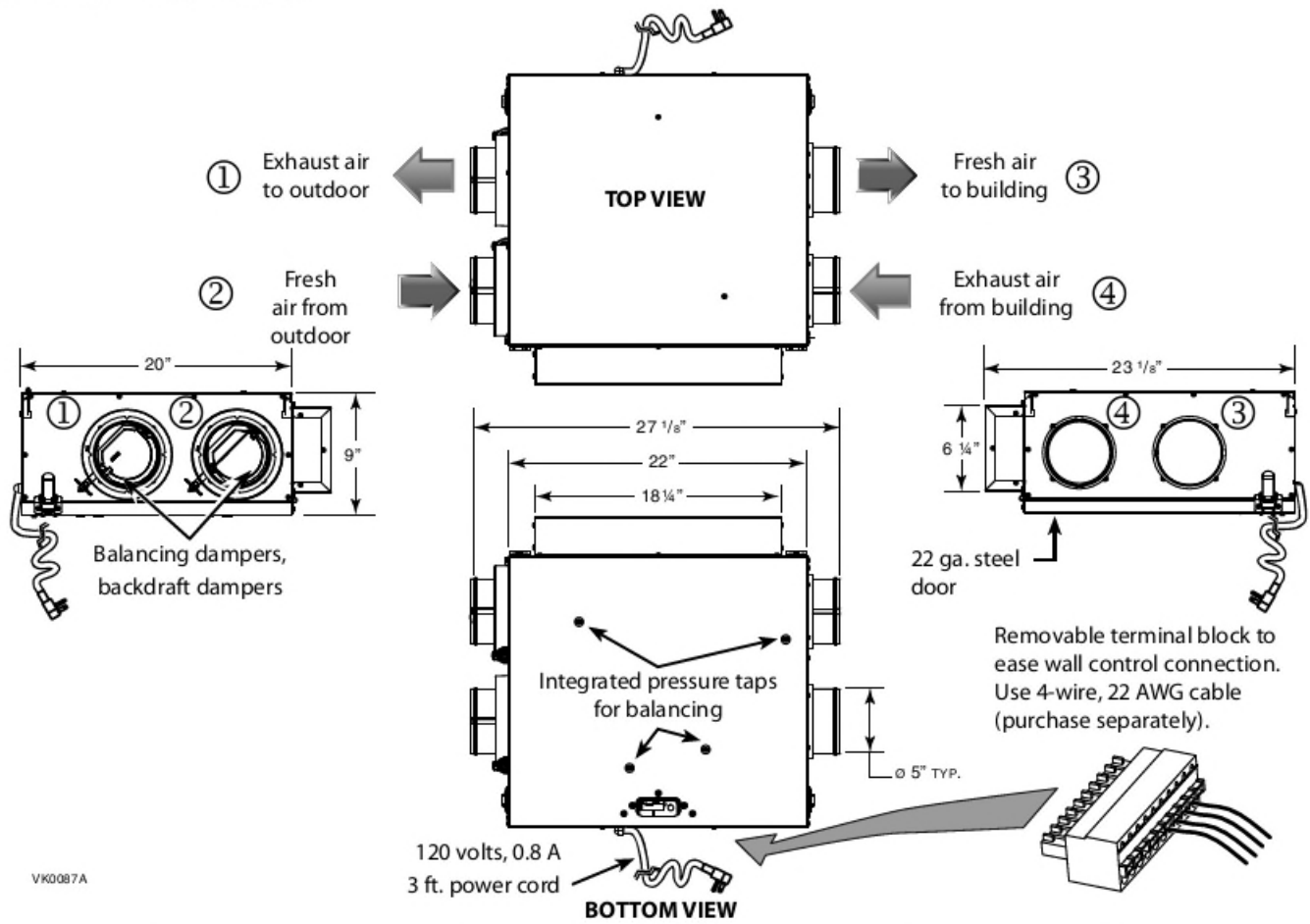

HORIZONTAL INSTALLATION ONLY

Allow 24" x 30" minimum for access door.

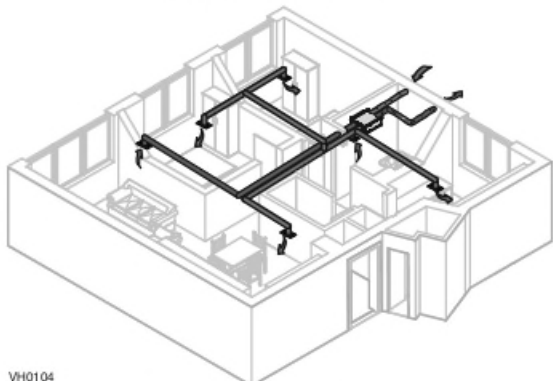

Example of a fully ducted installation

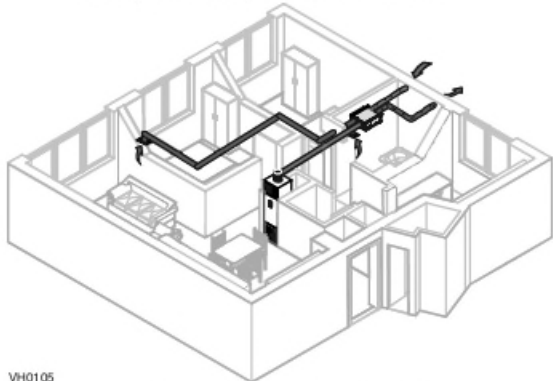

Example of a central draw point installation

UNIQUE 3 EASY STEPS FOR CEILING INSTALLATION

- 1 Mount brackets to ceiling.
 - 2 Bend integrated hooks (2 on the same side) and hang the unit.
 - 3 Clip the other side of the unit to the brackets.
- Integrated dampening device to prevent vibration transmission
- VOQ255

OR ALTERNATE INSTALLATION

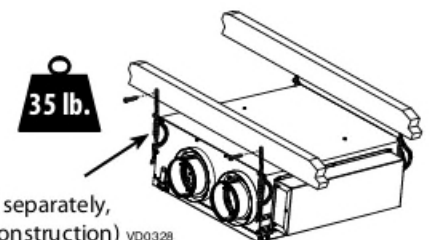

Simplified Installation (connection to a forced air system)

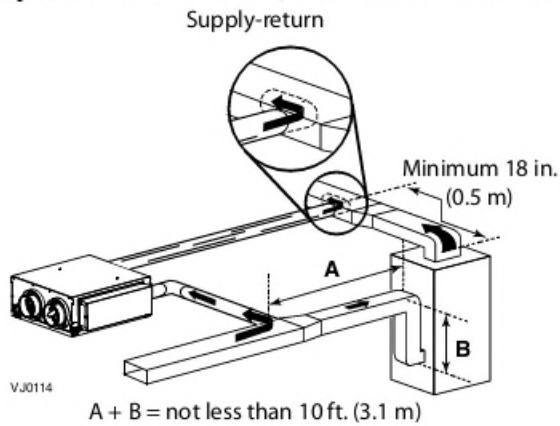

OR

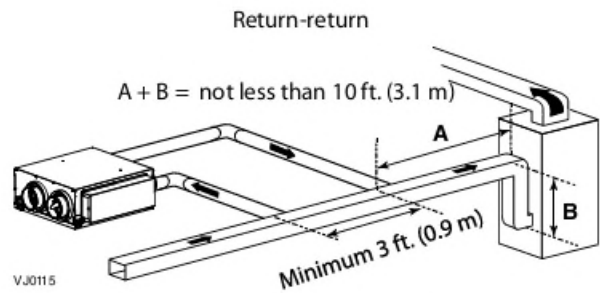

The furnace blower operation must be synchronized with the ERV blower operation.

VENTILATION PERFORMANCE

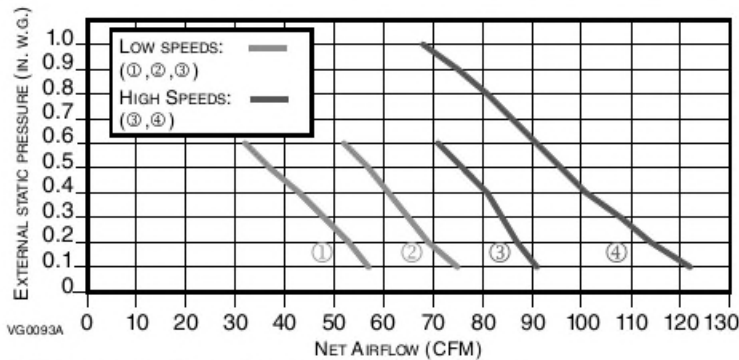

NOTE: Low speed ① and high speed ④ are factory set, low speed ② and high speed ③ are selectable.

ENERGY PERFORMANCE

SUPPLY TEMPERATURE	NET AIR FLOW			POWER CONSUMED WATTS	SENSIBLE RECOVERY EFFICIENCY	APPARENT SENSIBLE EFFECTIVENESS	LATENT RECOVERY/MOISTURE TRANSFER	
	°C	°F	L/S					CFM
HEATING								
0	32	23	48	82	40	67	75	55
0	32	31	65	110	54	65	73	51
0	32	40	85	144	68	61	69	47
-25	-13	23	48	82	55	61	76	59
-25	-13	31	65	110	70	60	73	54
COOLING								
35	95	23	48	82	40	TOTAL RECOVERY EFFICIENCY		54

NOTE: All specifications are subject to change without notice.

Acoustic Noise Power Chart (dBA)

Airflow	Fresh air to building port	Exhaust air from building port
100 CFM at 0.4 in. w.g.	69.0 dBA	58.1 dBA
55 CFM at 0.1 in. w.g.	59.3 dBA	49.8 dBA

The data shown on left chart come from measurement performed according to ISO 5136 Standard. These data represent the sound power directly measured at the fresh air distribution port and exhaust air from building port. To get the actual noise level in the room, consider noise attenuation resulting from total ductwork installation.

Coldshield™ Protection

ERV UNIT MODES BASED ON SUPPLIED AIR TEMPERATURE

- ERV unit is equipped with an electronic supplemental protection to stop air distribution in dwelling if air distribution temperature drops below freezing point, due to abnormal conditions.

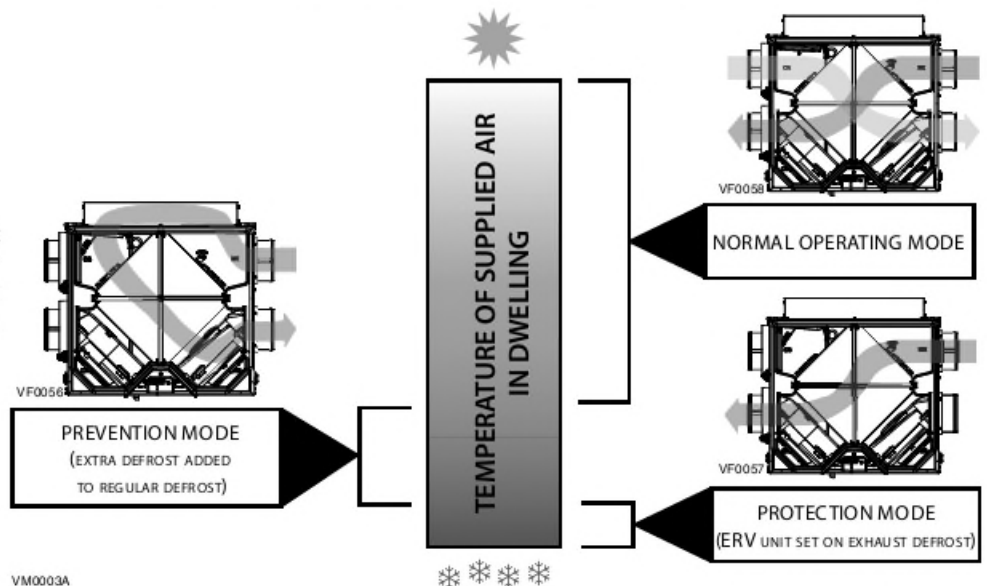

VM0003A

BROAN ERV100 PLUS ARCHITECTURAL SPECIFICATIONS

AIRFLOW

- High static pressure backward blowers shall perform a minimum of 68 CFM @ 1.0 in. w.g.
- Optional high speed: 85 CFM
- Optional low speed: 65 CFM

CONSTRUCTION

- Housing shall be made of 22 ga. galvanized steel
- Door shall be made of 22 ga. pre-painted steel
- Insulation shall be made of one-piece molded expanded polystyrene, UL 94 HF-1 certified
- 5" diameter ports shall be made of galvanized steel
- Door hinges and latches shall be made of steel
- Cold side ports shall have plastic ring to allow vapor barrier sealing
- Unit construction and components shall be UL and CSA certified
- Unit shall operate all year long without drain
- Weight shall not exceed 35 lb.
- Fresh air from outdoor and Exhaust air to outdoor ports shall be located on same side
- Backdraft damper shall be integrated in cold exhaust ports
- ERV unit shall be HVI certified and ENERGY STAR® qualified

MOTORS

- Unit shall have two high reliability, external rotor PSC motors, totally enclosed and thermally protected
- The backward blowers shall support high static pressure environment
- The insulation class shall be B

FILTERS

- ERV unit shall have two washable 20 ppi reticulated polyester urethane foam filters, UL 900 class 2 certified
- Optional MERV 8 filter kit, part no. V21030

ERV CORE

- The ERV core shall be a crossflow aluminum-polymerized paper core, UL723 certified
- Hydroscopic polymer exchange water by direct vapor transfer shall use molecular transport without the need of condensation
- The ERV core shall be constructed of alternate layers of corrugated aluminum material and polymeric bactericide dessiccant impregnated media; and shall not promote growth of mold or bacteria
- The ERV core design shall be made of rectangular flutes to provide very low pressure drop values

Controls

- Choice of low voltage main controls (not included) shall be energized by ERV unit
- Optional low voltage auxiliary controls (not included) shall be energized by ERV unit
- Removable terminal block shall be included for quicker low voltage control connections
- A LED indicator shall indicate defrost selected mode as well as error codes
- ERV unit shall be permanently energized, no control shall be installed on power supply of unit

Air Flow Balancing

- Unit door shall be equipped with pressure taps as well as a balancing chart to allow verification of balancing of the ERV unit
- Balancing damper shall be integrated in cold supply and cold exhaust ports
- Motorized damper shall be integrated in ERV unit, adjacent to the cold supply port

Defrosting System

- Unit shall allow 3 quick-access defrost modes:
 - Standard (factory set regular mode)
 - Plus (extended defrost for colder areas)
 - Discretion (keeps the same speed when performing defrost as performing ventilation)
- Unit shall be equipped with Coldshield™ protection to stop air supply in dwelling if air supply temperature drops below freezing point, due to abnormal conditions.

Acoustic Noise Power

- The unit shall have a maximum acoustic noise power of 59.3 dBA on low speed at 0.1 in. w.g. and 69.0 dBA on high speed at 0.4 in. w.g., measured at fresh air to building port.
- The unit shall have a maximum acoustic noise power of 49.8 dBA on low speed at 0.1 in. w.g. and 58.1 dBA on high speed at 0.4 in. w.g., measured at exhaust air from building port.

Warranty

Unit shall be protected by a 5-year warranty on parts only, with the original proof of purchase.

Requirements and standards

- Shall be HVI certified as per CSA C439 Standards
- Shall be ENERGY STAR® qualified
- Shall comply with the UL 1812 requirements regulating the installation of Energy Recovery Ventilators
- Shall comply with the CSA C22.2 no. 113 Standard applicable to ventilators
- Shall comply with CSA C444 requirements regulating the installation of Energy Recovery Ventilators

Project:	REMARKS
Location:	
Part no.: ERV100SP	
Qty.:	
Submitted by: _____ Date: _____	

