

▶▶▶ FREEDiM SERIES WIRELESS CONTROLLERS

FREEDiM Series Universal Receiver

- ▶ 60W Capacity
- ▶ Power failure memory
- ▶ Multiple receivers can be used on a single power supply or within a room to achieve multiple zones of control
- ▶ Install inline between power supply and lights.

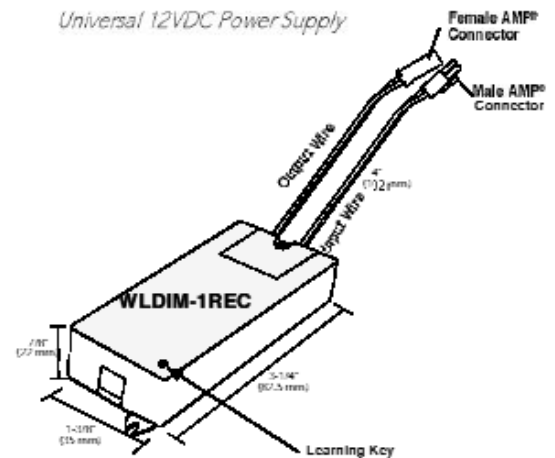
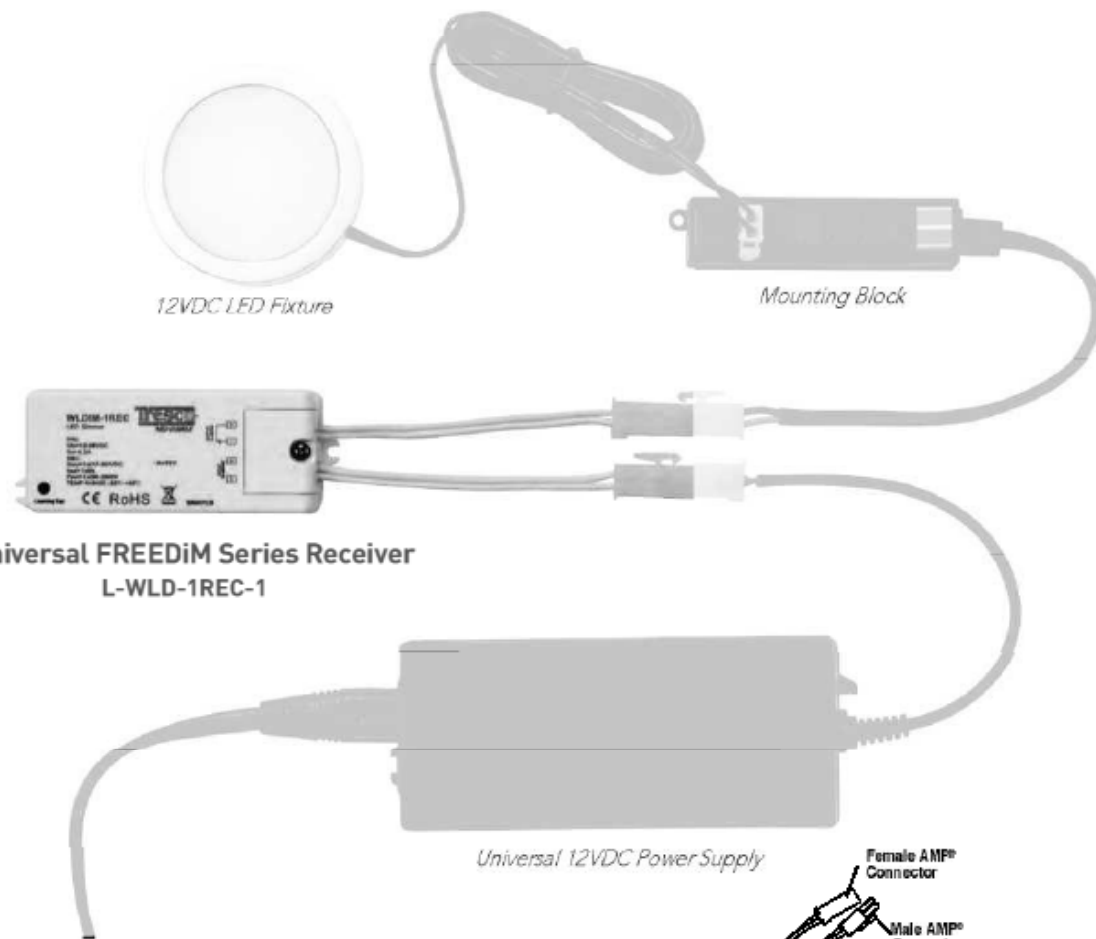

Part #	Description
L-WLD-1REC-1	12VDC 60W Universal FREEDiM Series Receiver

A single receiver can be programmed to up to 8 different FREEDiM Series remotes/dimmers

PATENT PENDING

FREEDiM Series Deco Wall Dimmer

- ▶ Available in single and 2-zone
- ▶ Can be programmed to multiple receivers for more lighting control
- ▶ Black, white, or light almond finish
- ▶ Fits Decora® style wall plates
- ▶ 65 ft. range of control from dimmer to receiver
- ▶ Controls all Tresco dimmable low voltage lights
- ▶ Unlike traditional hardwire dimmers, you can control the same set of lights from multiple Deco Wall Dimmers



▶ Easily remove switch from docking tray to replace batteries or use as a remote dimmer



▶ Can be mounted to standard wall electrical boxes or to drywall

FREEDiM
WIRELESS CONTROL

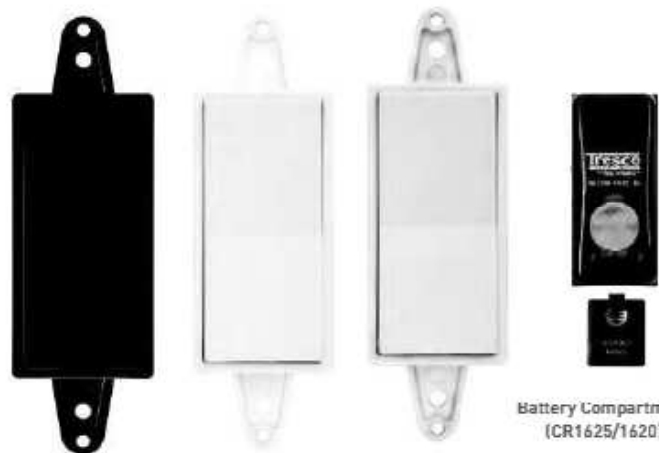

Battery Compartment (CR1625/1620)

Also available in 2-Zone:

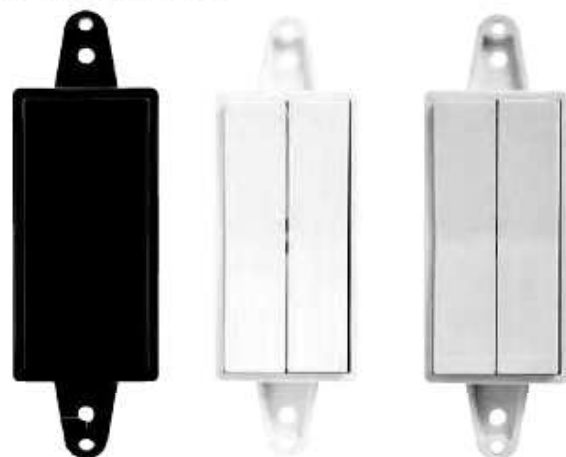

FREEDiM Series Deco Wall Dimmer - Single Zone

Part #	Description
L-WLD-1WAL-**-1	FREEDiM Series Deco Wall Dimmer

**Insert BL for Black, WH for White, LA for Light Almond

FREEDiM Series Deco Wall Dimmer - Two Zone

Part #	Description
L-WLD-2WAL-**-1	FREEDiM Series 2 Zone Deco Wall Dimmer

**Insert BL for Black, WH for White, LA for Light Almond

A single dimmer can be programmed to up to 10 different receivers. Must have at least one receiver (WLD-1REC-1) to operate

Universal FREEDiM Series Receiver

Part #	Description
L-WLD-1REC-1	12VDC 60W Universal FREEDiM Series Receiver

A single receiver can be programmed to up to 8 different FREEDiM Series remotes/dimmers

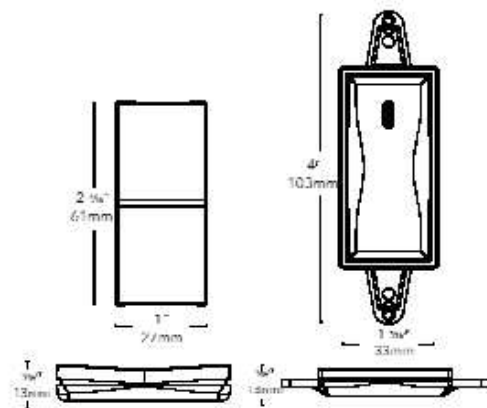

▶▶▶ FREEDiM SERIES WIRELESS CONTROLLERS

FREEDiM Series Micro Dimmer

- ▶ Single zone wireless dimmer
- ▶ Black or nickel finish
- ▶ Easy to replace, long life lithium battery
- ▶ 65 ft. range of control from dimmer to receiver
- ▶ Controls all Tresco dimmable low voltage lights



▶ Integrated magnet allows for mounting to refrigerator or other metallic surfaces



▶ Easy 2 screw installation

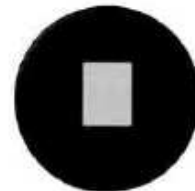

Integrated Magnet



Battery Compartment (CR2025)

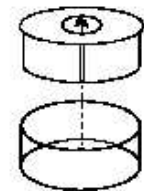
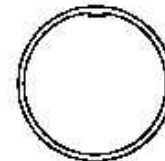
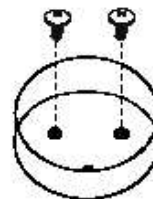

Part #	Description
L-WLD-1RND-BL-1	FREEDiM Series Micro Dimmer, Black
L-WLD-1RND-NI-1	FREEDiM Series Micro Dimmer, Nickel

A single dimmer can be programmed to up to 10 different receivers.
Must have at least one receiver (WLD-1REC-1) to operate

Universal FREEDiM Series Receiver

Part #	Description
L-WLD-1REC-1	Universal FREEDiM Series Receiver

A single receiver can be programmed to up to 8 different FREEDiM Series remotes/dimmers

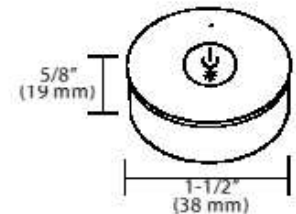

FREEDiM Series 3 & 6 Zone Remotes

- ▶ Independent control of 3 or 6 lighting zones [respectively] from single remote
- ▶ Program additional receivers to separate the lighting in a room into multiple zones that you can control independently
- ▶ Set brightness levels of all of the zones to a desired level then save as a "Scene"
- ▶ 65 ft. range of control from remote to receiver
- ▶ Controls all Tresco dimmable low voltage lights



▶ Integrated magnet allows for mounting to refrigerator or other metallic surfaces



▶ Docking tray can be screw mounted. Remotes attach to tray magnetically

FREEDiM
WIRELESS CONTROL



3-Zone
(CR2032)

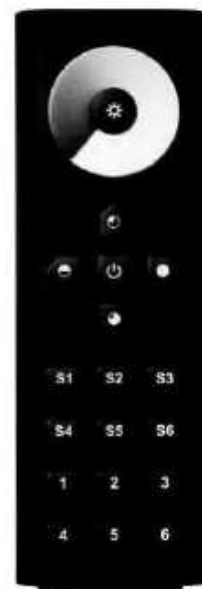

6-Zone
(3 X AAA)

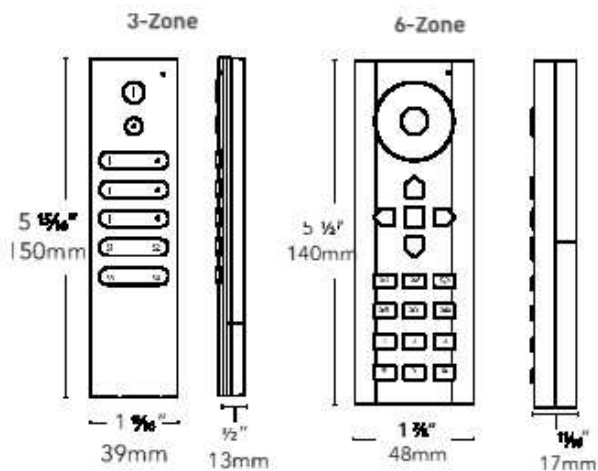

Part #	Description
L-WLD-3RMT-BL-1	FREEDiM Series 3-Zone remote, Black
L-WLD-6RMT-BL-1	FREEDiM Series 6-Zone Remote, Black

6-Zone batteries not included

Must have at least one receiver (WLD-1REC-1) to operate

Universal FREEDiM Series Receiver

Part #	Description
L-WLD-1REC-1	Universal FREEDiM Series Receiver

A single receiver can be programmed to up to 8 different FREEDiM Series remotes/dimmers

▶▶▶ 12VDC Oval Controllers



Proximity Controller
Swipe hand across to turn on/off

- ▶ Max wattage: 27W
- ▶ Sensor range: 2" (50 mm)
- ▶ Cable input: 79" (2 m)
- ▶ Cable output: 6" (152 mm)
- ▶ Finish: Nickel/Black



Door Sensor Controller
Door open, light on; door closed, light off

- ▶ Max wattage: 60W
- ▶ Sensor range: 2" (50 mm)
- ▶ Cable input: 79" (2 m)
- ▶ Cable output: 6" (152 mm)
- ▶ Finish: Nickel/Black

NOW
60W



Motion Controller
Turns on when human motion is detected

- ▶ Max wattage: 27W
- ▶ Sensor range: 0-5' (1500 mm)
- ▶ Viewing degree: 100°
- ▶ Time on: 30 secs if no motion
- ▶ Cable input: 79" (2 m)
- ▶ Cable output: 6" (152 mm)
- ▶ Finish: Nickel/Black



Dimmer Controller
Touch on/off and 0-100% dimming control

- ▶ Max wattage: 60W
- ▶ Cable input: 79" (2 m)
- ▶ Cable output: 6" (152 mm)
- ▶ Finish: Nickel/Black
- * Hold finger down for dimming

NOW
60W

Part #	Description
L-LED-OVLTD-**	60W 12VDC Oval Recess/Surface Mnt. Touch Dimmer
L-LED-OVLDS-**	60W 12VDC Oval Recess/Surface Mnt. Door Sensor
L-LED-OVLS-**	27W 12VDC Oval Recess/Surface Mnt. Motion Sensor
L-LED-OVLPS-**	27W 12VDC Oval Recess/Surface Mnt. Proximity Sensor
L-DB1732-1	17/32" (13.5 mm) Drill Bit for Recess Mount

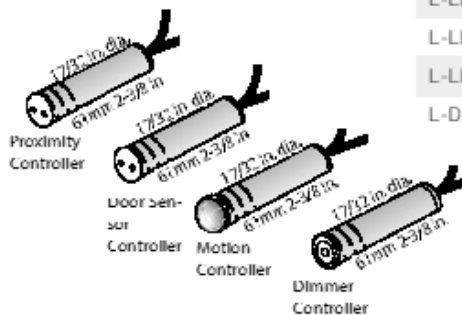

**Available in Black (BL) and Nickel (NI)
Surface mount plate packaged with each controller.

▶▶▶ 12VDC Remote Control Dimmers

Remote Control LED Dimmers feature radio-frequency, remote-control dimming to adjust lights from anywhere in the room up to 30' (9 m). The remote control provides on/off power and dims lights from 100%-1%.

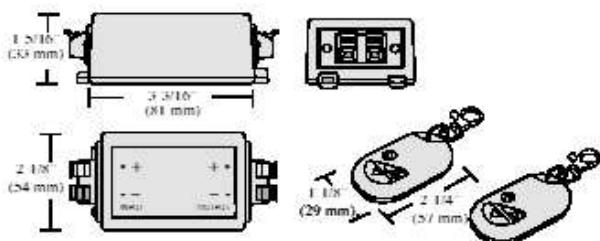

Universal Remote Dimmer

- ▶ Controls up to 5A/60W of LED lighting
- ▶ Features a built-in memory that recalls the last setting when turned on
- ▶ Comes with two remote controls (one as a backup)
- ▶ No line of sight required
- ▶ Can control multiple dimmers in same room with single remote control for universal dimming

Dedicated Remote Control Dimmer

- ▶ Controls up to 5A/60W of LED lighting
- ▶ Features a built-in memory that recalls the last setting when turned on
- ▶ No line of sight required
- ▶ Comes with two remote controls (one extra, as a backup) that are synchronized to control the same dimmer
- ▶ Can use multiple independently controlled dimmer in the same room

Part #	Description	Suggested List Price
L-LED-DIMRMT-12V8A-1	LED Dedicated Remote Control Dimmer, 12VDC 96W	\$80.05
L-LED-DIMRMT-12V8A-U-1*	LED Universal Remote Control Dimmer, 12VDC 96W	\$80.05

*Recommended not to exceed 3 per room

Placement of multiple dimmers in a room may be critical for proper function depending on set-up and obstacles.

Both models of the Remote Control LED Dimmer provide on/off power and dim lights from 100%-1%. The dedicated remote control independently controls one specific dimmer in a room. The Universal Remote Control (U) controls multiple dimmers in a room.

▶▶▶ Touch On/Off Switch

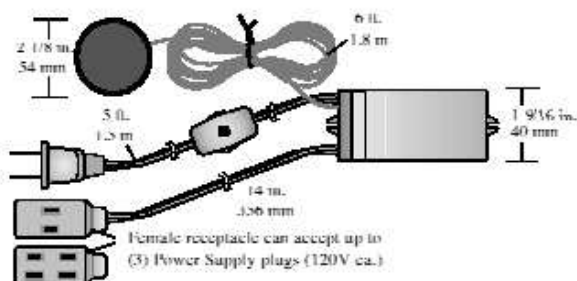

Controls 12V Plug-in Power Supplies

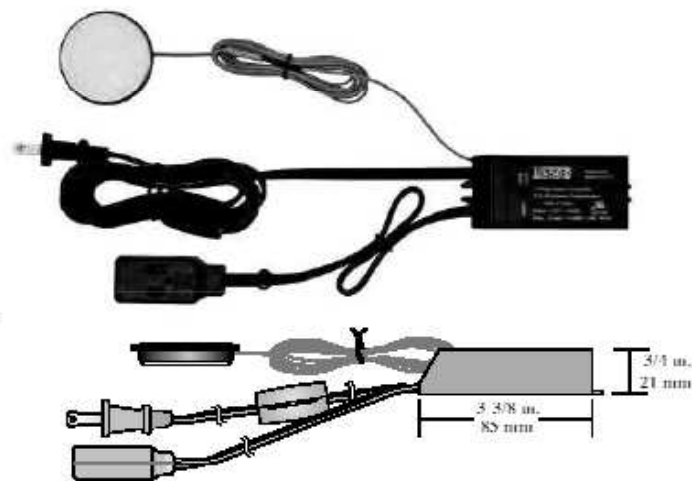

Part #	Description
L-TS2-72-1	Touch On/Off w/Cord And Touch Pad. Black, 200W

On/off switch touch pad attaches to surface with adhesive backing. Power supply plugs into on/off switch.

12VDC Manual In-Line Rotary Dimmer

- ▶ 4A/48W capacity
- ▶ 100-0% dimming and on/off power
- ▶ 79" [2 m] input lead snaps into power supply mounting block with male AMP® connector
- ▶ 8" [203 mm] output connects to run of light with female AMP® connector



Part #	Description
L-LED-DIMCON-BL-1	LED Black Inline Rotary Dimmer, 12VDC 48W
L-LED-DIMCON-WH-1	LED White Inline Rotary Dimmer, 12VDC 48W

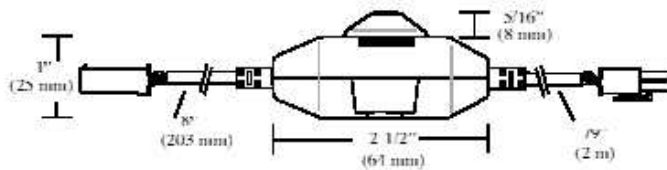
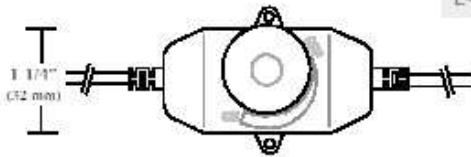

Round Switch - 12V

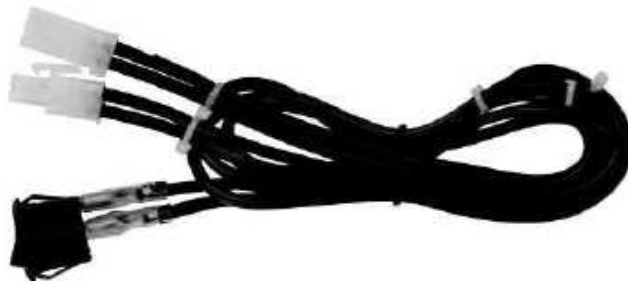

Front View

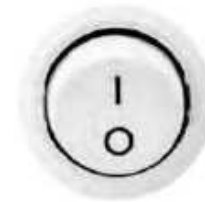
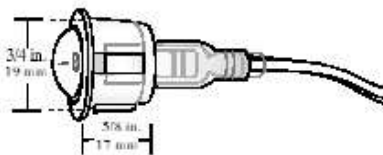

Available in White & Black

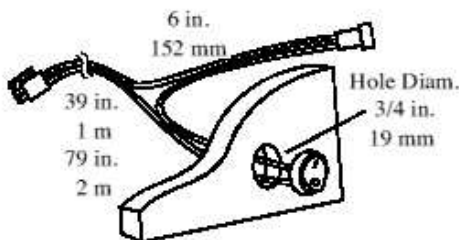

Part #	Description
L-RDSW-1M-BL-1	Black Rocker Switch w/ 39" [1 m] Lead, 12VAC/DC
L-RDSW-1M-WH-1	White Rocker Switch w/ 39" [1 m] Lead, 12VAC/DC
L-RDSW-2M-BL-1	Black Rocker Switch w/ 79" [2 m] Lead, 12VAC/DC
L-RDSW-2M-WH-1	White Rocker Switch w/ 79" [2 m] Lead, 12VAC/DC

3/4" [19 mm] hole required.

▶▶▶ 12VDC Wireless Tri-Mitter

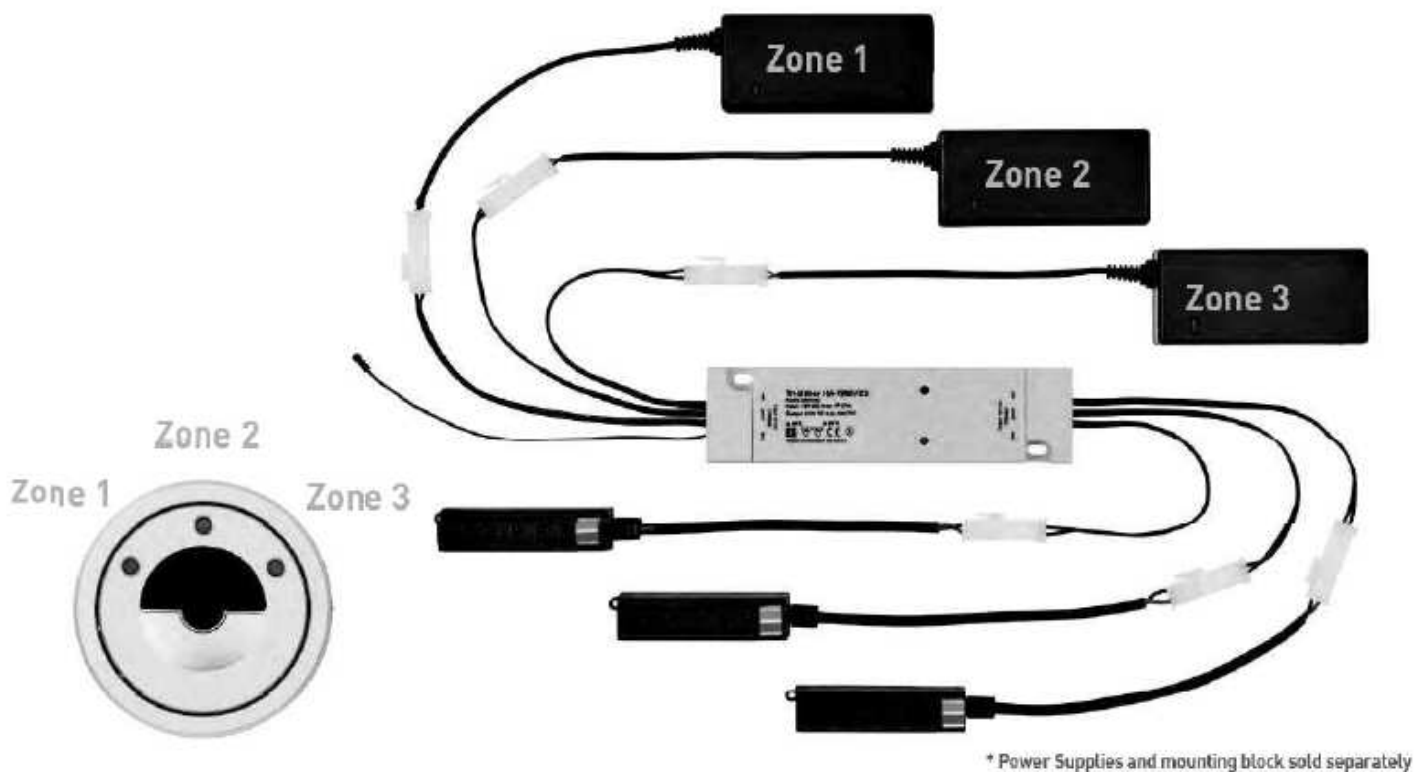

- ▶ Wireless switching or dimming of up to 3 independent 12 volt circuits [zones]
- ▶ Max. 36W load capacity per zone
- ▶ Controller uses 3V CR2032 battery
- ▶ 65' [20 m] range of control from controller to receiver
- ▶ Touch for on/off control; hold down to cycle dimming 1-100%
- ▶ Low profile recessed installation
- ▶ A single receiver can be programmed to up to 9 controllers

Hole size 1 1/4 in [44 mm] in diameter, 1/2 in [13 mm] depth



Part #	Description
L-HTRISSET-1	12VDC Tri-Mitter Set (Wireless Controller + Receiver)
L-HTRICON-NI-1	12VDC Tri-Mitter Controller Nickel (Wireless Controller Only)

12VDC MultiSwitch Station

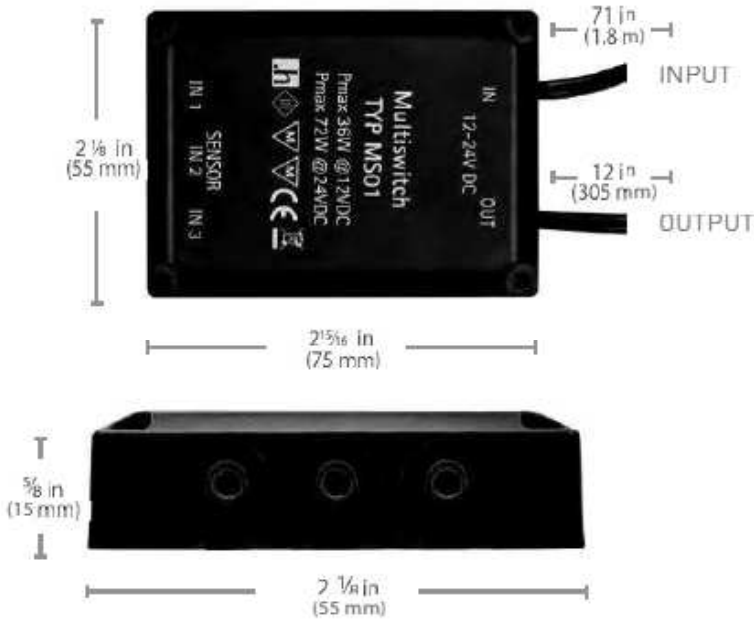

- ▶ Connect up to 3 sensors of the same style to universally control run of lights
- ▶ Max. 36W load capacity
- ▶ Soft start on/off function

Part #	Description
L-HMSMCU-BL-1	12VDC MultiSwitch Station

Touch Dimmer on/off 36W

Multiswitch station required for operation

- ▶ Push button with dimming function
- ▶ Low profile recessed installation
- ▶ Touch for on/off control; hold down to cycle dimming 1-100%
- ▶ Finish: Nickel/Black
- ▶ Adjustable settings allow for simple on/off operation or Dimming + on/off

Hole size 1/2 in (13 mm) in diameter, 1 in (25mm) depth

Part #	Description
L-HMS1D-NI-1	12VDC MultiSwitch Touch Dimmer, Nickel
L-HMS1D-BL-1	12VDC MultiSwitch Touch Dimmer, Black



▶▶▶ Motion Controller 36W

Multiswitch station required for operation

- ▶ Energy saving PIR motion sensor
- ▶ Viewing degree: 100°
- ▶ Time on: 10 seconds if no motion
- ▶ Sensor Range: 0-6.5' [2 m]
- ▶ Finish: Nickel/Black

Part #	Description
L-HMSMS-NI-1	12VDC MultiSwitch Motion Sensor, Nickel
L-HMSMS-BL-1	12VDC MultiSwitch Motion Sensor, Black



▶▶▶ Door/Proximity Controller 36W

Multiswitch station required for operation

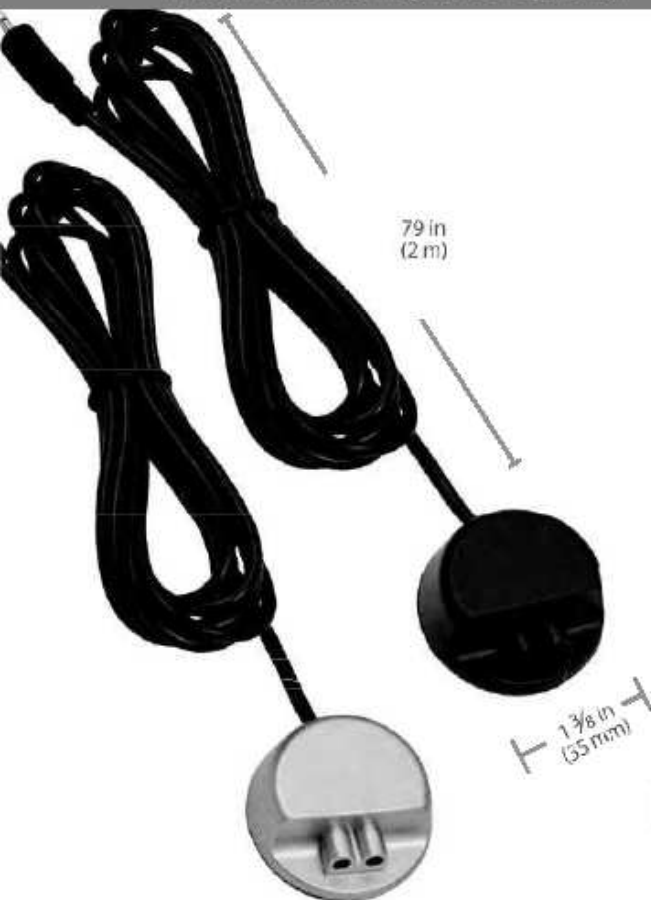

Adjustable Settings Switch



- ▶ Adjustable settings allow for switch to function as door sensor or proximity controller (hand swipe on/off)
- ▶ Hand Sensor Range: 0.2-2.0" [5-50 mm]
- ▶ Door Sensor Range: 0.2-4.7" [Reflection Foil included]
- ▶ Energy saving auto shut-off turns lights off after 3 minutes when in door sensor mode
- ▶ Finish: Nickel/Black

Part #	Description
L-HMSHDS-NI-1	12VDC MultiSwitch Door/Proximity Sensor, Nickel
L-HMSHDS-BL-1	12VDC MultiSwitch Door/Proximity Sensor, Black