

T-DT60W-12V-HW

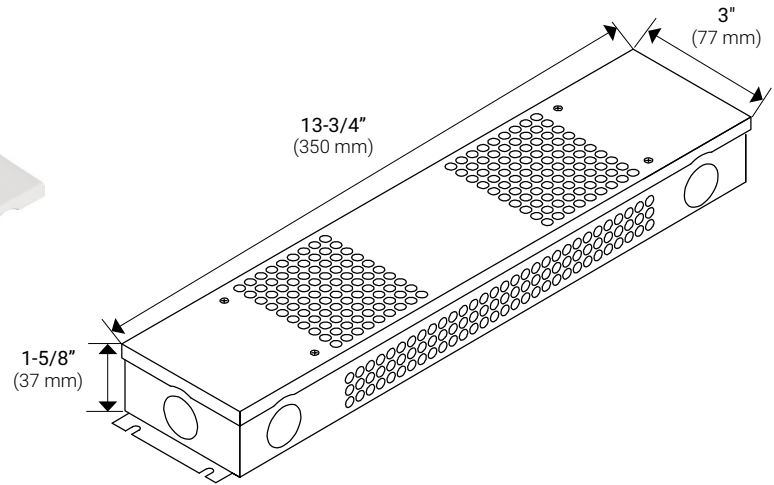

60 WATT HARDWIRED POWER SUPPLY

PART NUMBER	DESCRIPTION	DIMENSIONS	CORD LENGTH (included separate)	VOLTS	AMPS
T-DT60W-12V-HW	60 watt 12-volt DC dimmable class 2 LED hardwired.	13-3/4" x 3" x 1-5/8" 350 mm x 77 mm x 37 mm	39" (3 ft. 3 in.) 990.6 mm	12	5

FEATURES

- Power supply already located in a junction box
- 2-prong power cord included but not installed
- Dims on the 120 volt side with Magnetic Low Voltage (MLV) Dimmers
- 12-volt power supplies over 60 watts are UL Listed for commercial use, and are not UL Class 2 Listed for residential
- 3-year limited warranty
- Designed for indoor application

TECHNICAL INFORMATION

Series	Hardwired Power Supply Series
Input Voltage	120 volt AC
Output Voltage	12-volt DC
Output Wattage	60 watts
Dimmable	Dimmable (MLV)
Rating	cULus Listed
Rated Life	30,000 hrs
Mounting	Screw holes located in the four corners of junction box
Operating Temperature	-40°F to 140°F (-40°C to 60°C)
Environment	Dry location
Construction Material	Full protection plastic housing inside a metal junction box
Warranty	3 years

INSTALLATION LOCATIONS

- Above Cabinet / Open Soffits
- Interior Wall Cabinet
- Base Cabinets
- Open Covers
- Any Available & Accessible Outlets

DO NOT INSTALL IN AN ATTIC