

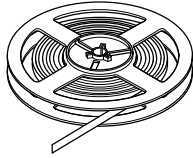

LED2080
LED3080



833.74.3xx
833.76.3xx

732.28.346

A

+

B

B

x	12V
2000	833.95.704

x	24V
2000	833.95.710

+

C

x	12/24V
50	833.89.200
500	833.89.201
2000	833.89.202

D

833.89.209

E

833.89.189

HDE 18.03.2019

12/24 V System		W/m	← max. (m) →					 mm	T _A
			20W	40W	60W	90W	270W		
12V	LED2080	9,6	2,0	4,1	6,2			5.000 x 10 x 1,3	-20 °C - +45 °C
24V	LED3080	9,6	2,0	4,1		9,3	9,3		-4 °F - +113 °F

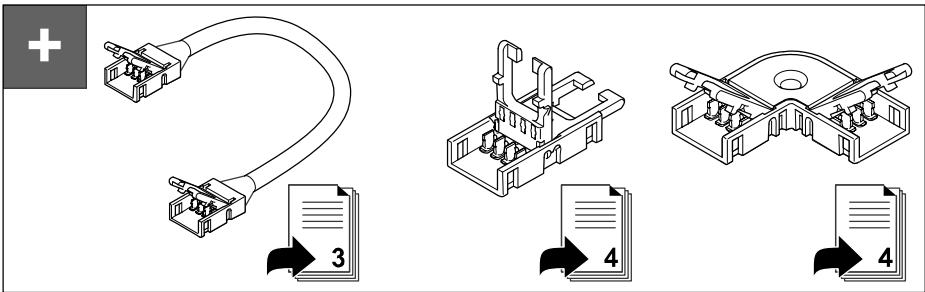
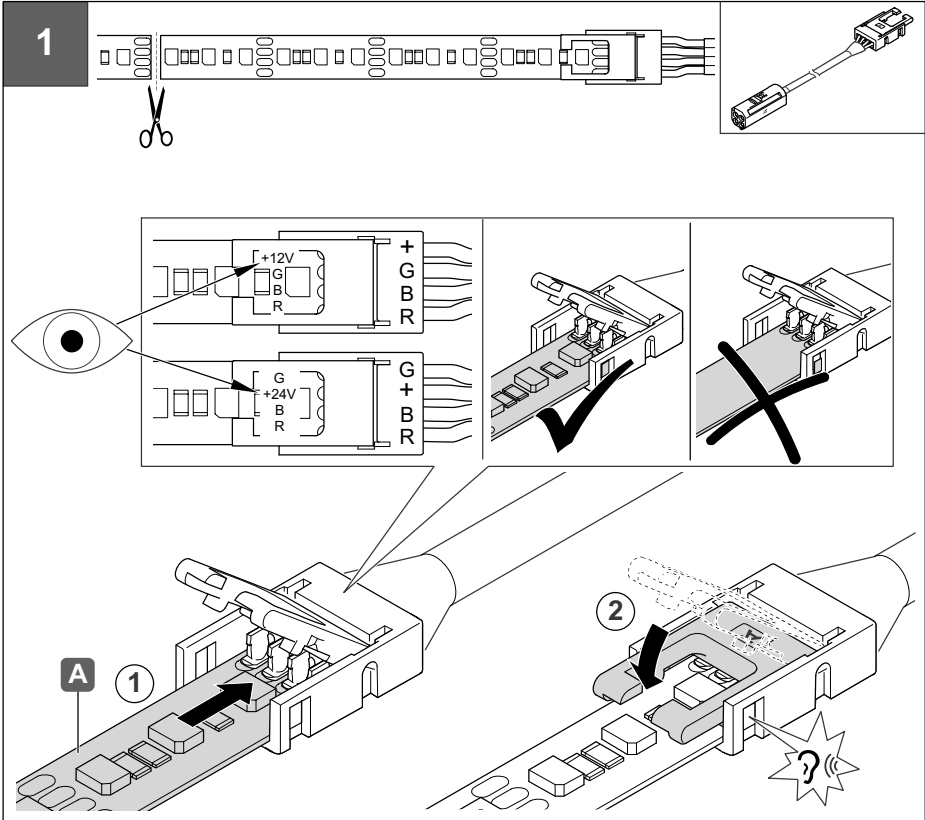
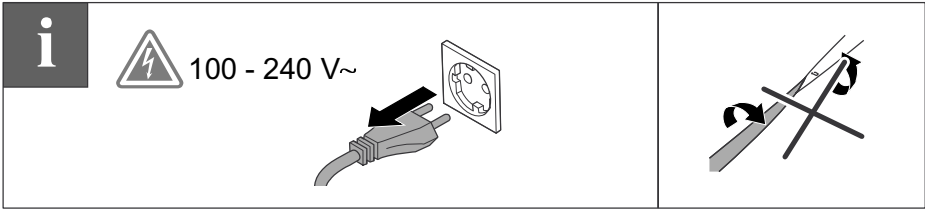

732.28.346

HDE 18.03.2019

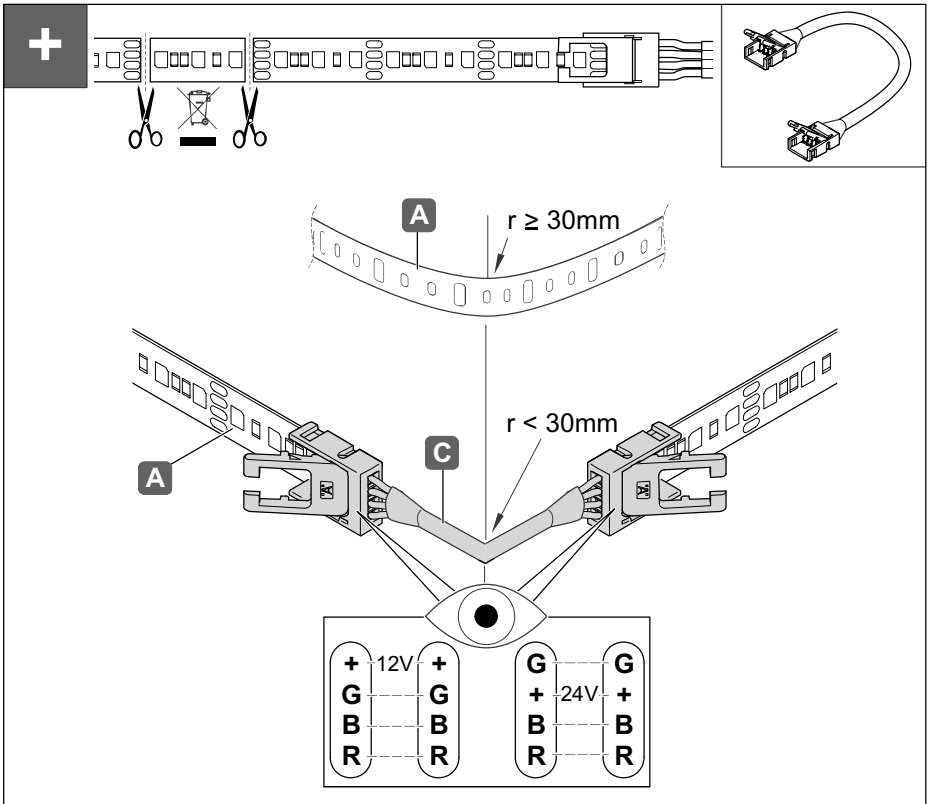
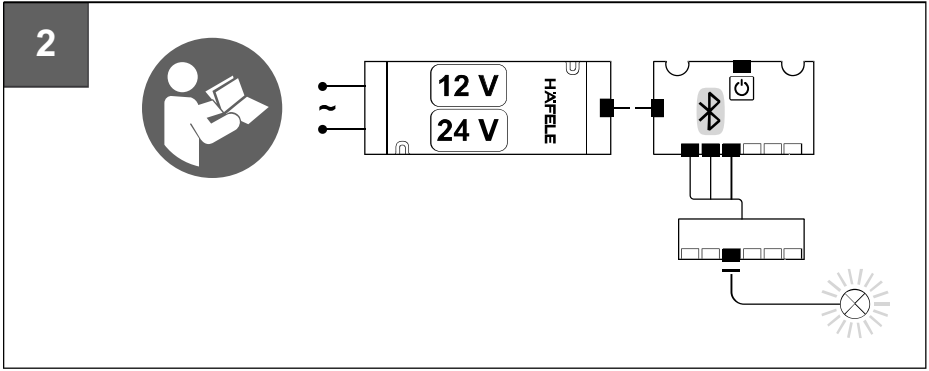

732.28.346

HDE 18.03.2019

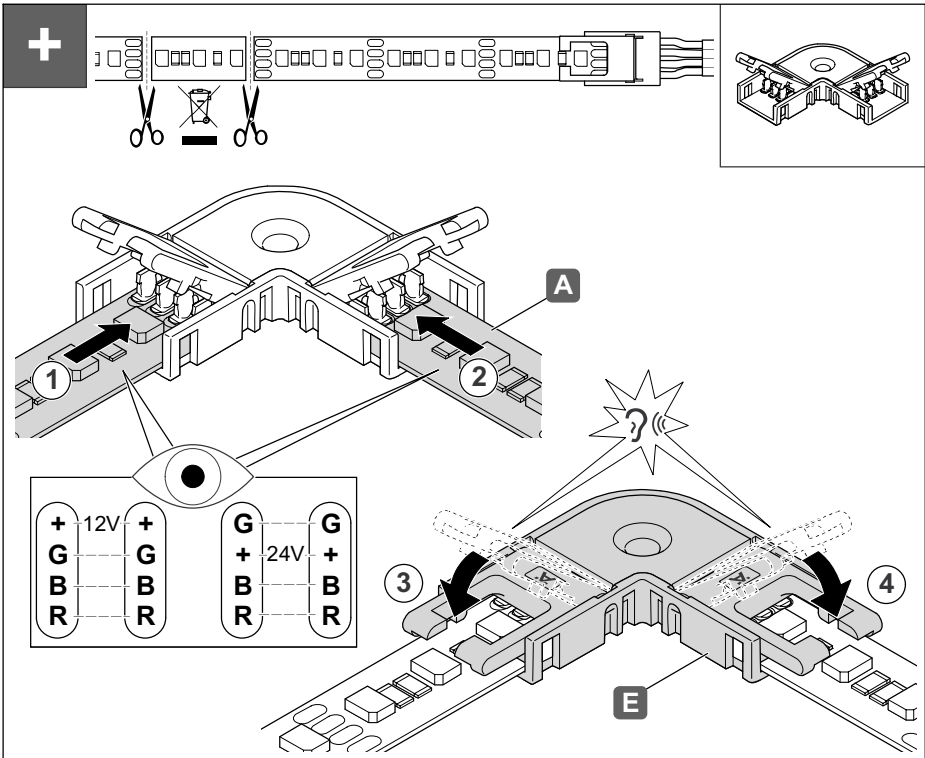
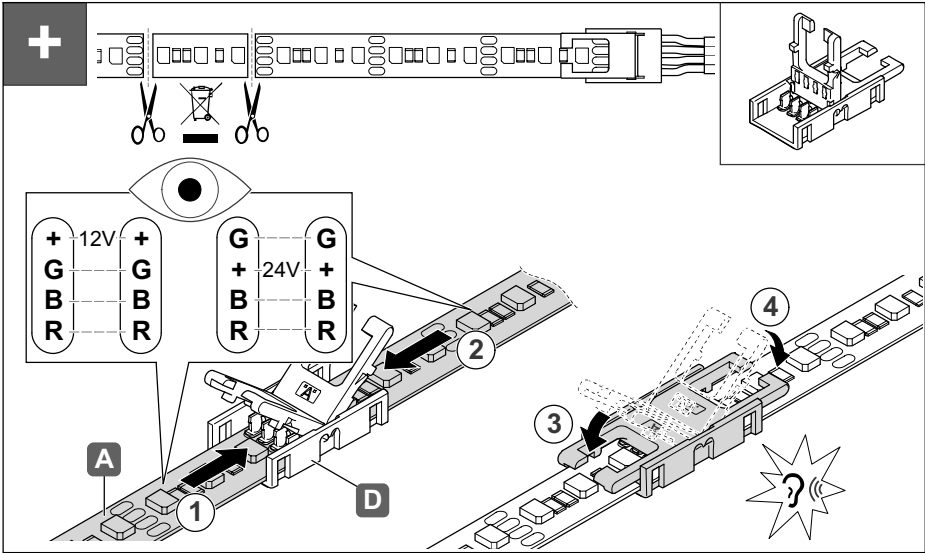

732.28.346

HDE 18.03.2019