

Touch Release and Heavy-Duty Touch Release
Stays closed, push to open
Optional Face Frame Brackets

APPLICATIONS: For use in wood pedestals, dresser, and desk drawers, casework, residential and kitchen cabinetry. **Heavy Duty Touch Release provides stronger stay-closed feature. Not intended for lateral file* drawer applications. Use for side mount only. This product is covered by U.S. and various foreign patents issued and/or pending.**

3832TR/HDTR
QUICK REFERENCE BOX

Side Space: 1/2"+1/32"X2
Lengths: 12"-28"
Overall Slide
Dimensions: 1.80X1/2"
Load Rating: 100 lbs.*
Touch Release Feature

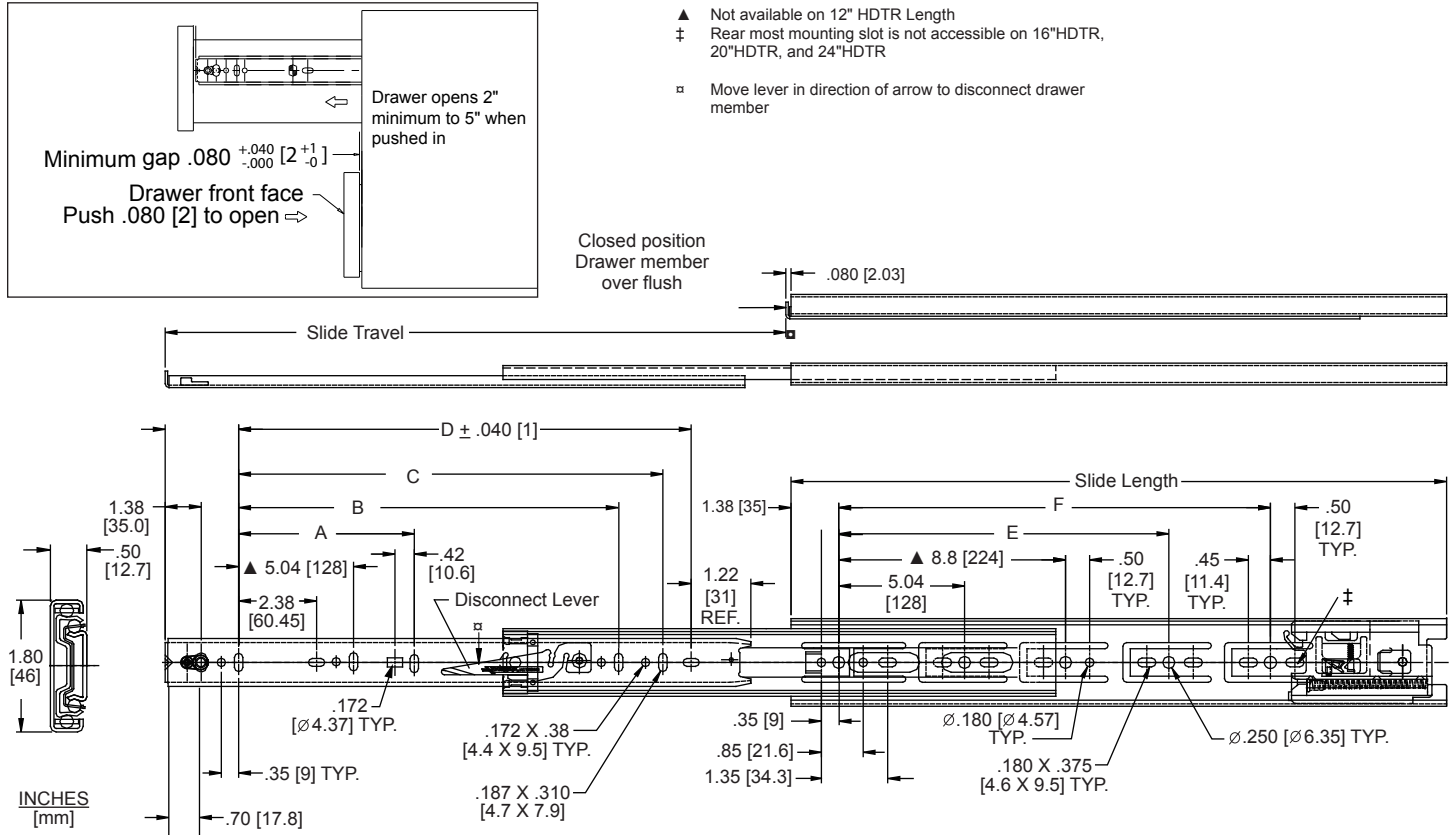

- ▲ Not available on 12" HDTR Length
- ‡ Rear most mounting slot is not accessible on 16"HDTR, 20"HDTR, and 24"HDTR
- Move lever in direction of arrow to disconnect drawer member

Finish Clear electroplate (C), black electroplate (CB), or white electrocoat (EW) finish (RoHS compliant)

Load Rating 100 lbs. [45.5 kg] per pair ♦

Length 12"-28" [300 mm-700 mm]

Hardware Flat head 6 mm Euro System screw or #8 pan head screw

Side Space .50" (+ .031-0.00) [12.7 mm] (+ 0.8-0.0)

Travel Full extension

Height 1.80" [45.7 mm]

Disconnect Handed lever disconnect

Mounting Side, optional face frame brackets

Features Drawer member vertical cam adjustment

Ball Bearings C and CB finish: Steel
EW Finish: Acetal polymer in drawer member

Part Number	Slide Length	3832TR Travel	A	B	C	D	E	F
3832-C12TR 3832-C12HDTR	11.81 [300]	12.00 [305]				7.58 [192]		
3832-C14TR 3832-C14HDTR	13.78 [350]	14.00 [356]				9.55 [242]		
3832-C16TR 3832-C16HDTR	15.75 [400]	16.00 [406]				11.51 [292]	11.34 [288]	
3832-C18TR 3832-C18HDTR	17.72 [450]	18.00 [457]		12.60 [320]		13.48 [342]	12.60 [320]	
3832-C20TR 3832-C20HDTR	19.69 [500]	20.00 [508]		12.60 [320]		15.45 [392]	15.12 [384]	
3832-C22TR 3832-C22HDTR	21.65 [550]	22.00 [559]	8.82 [224]	16.38 [416]		17.42 [442]	16.38 [416]	
3832-C24TR 3832-C24HDTR	23.62 [600]	24.00 [610]	8.82 [224]	16.38 [416]		19.39 [492]	13.86 [352]	18.90 [480]
3832-C26TR 3832-C26HDTR	25.59 [650]	26.00 [660]	8.82 [224]	16.38 [416]	20.16 [512]	21.36 [542]	13.86 [352]	20.16 [512]
3832-C28TR 3832-C28HDTR	27.56 [700]	28.00 [711]	8.82 [224]	16.38 [416]	20.16 [512]	23.33 [592]	13.86 [352]	21.42 [544]

NOTES: ♦ Drawer width should not exceed slide length.

* A lateral file drawer is wider than it is deep.
♦ Load rating based on 18" slides mounted in a 16" wide drawer cycled 50,000 times.

Drawer Box Preparation

1. Drawer box width should not exceed slide length.
2. Slides will not function properly if side space is less than .50" [12.7 mm]. For optimum performance, construct drawer 1-1/16" [27.0 mm] smaller than cabinet opening.

Overlay Mounting

1. Cabinet member installation:
 - Conventional mounting, See Figure 1.
 - 32 mm system mounting, see Figure 2.

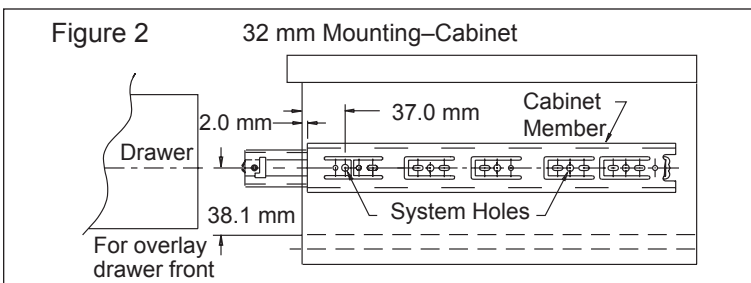
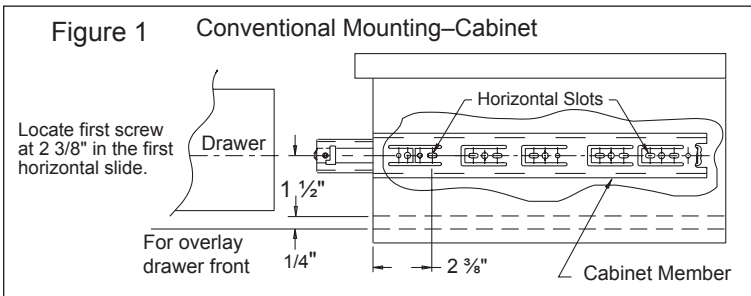

2. Use only the 32 mm system holes or the wood screw holes located at the tip of the breathing tabs. Do not use any other holes on the cabinet member for mounting (Figure 3).

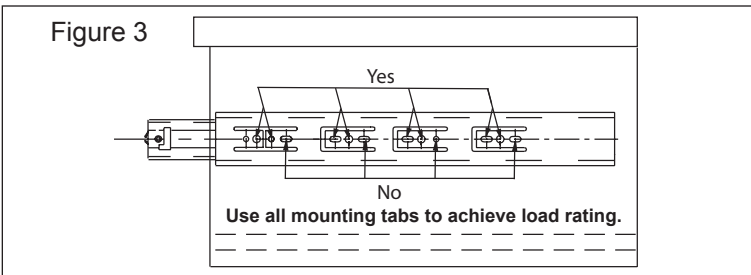

Inset Mounting Instructions

1. Mount the cabinet member .080" [2 mm] plus drawer front panel thickness back from the front of the cabinet.
2. Mount the drawer member flush to the back surface of the drawer front panel.

Drawer Member Installation

- See figure 4 for drawer member setback
- Install the drawer member with a screw through the cam adjuster and a screw through the hole or slot at the rear (Figure 5).

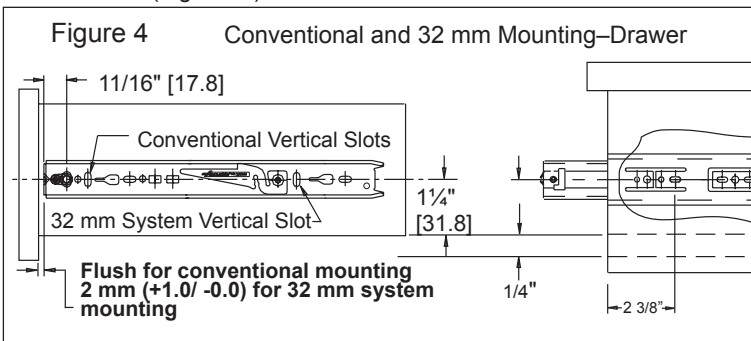

1. Make sure the ball bearing retainers in the cabinet side are fully forward. Install drawer into cabinet. Close the drawer.
2. For cam adjustment, open drawer and rotate the cam with a Phillips or Pozi screwdriver to vertically position the drawer in relation to the cabinet.

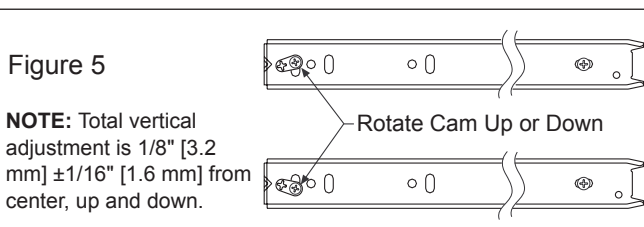

Install additional set screws to secure.

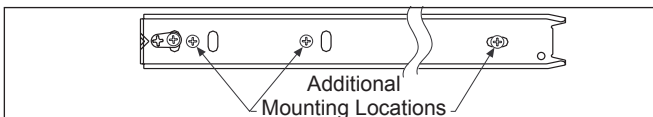

Slide Ordering Instructions

Complete your slide order for Accuride models 3832CTR and 3832CHDTR by specifying the following:

50 pair C 3832 C18 HDTR P
50 Pair C 3832 C18 TR D*

Total Required Slides _____
 Slide Finish _____
 Slide Model _____
 Slide Length _____
 Push Close/Open _____
 Polybag Packaging _____

*D-Pack only for 3832CTR

Optional Face Frame Brackets

Optional face frame brackets available. See Face Frame Conversion Kit technical sheet part number 4180-0661-XE for models 3832CTR and 3832CHDTR.

Packaging

Distributor (D) Pack: All lengths are packaged 10 pair per box. Polybag includes one pair of slides with mounting screws (3832CTR only).

Bulk (P) Pack: All lengths are packaged 10 pair per box. Slides and screws are ordered and packaged separately (3832CTR and 3832CHDTR).

Specifications

Slide members and ball retainers: Cold rolled steel
 Ball bearings: Carburized steel/acetel polymer
 RoHS compliant

NOTE: Specifications, materials, prices, terms, and delivery are subject to change without notice.