

PART LIST

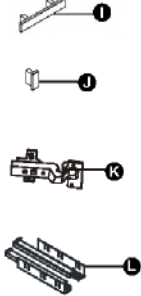
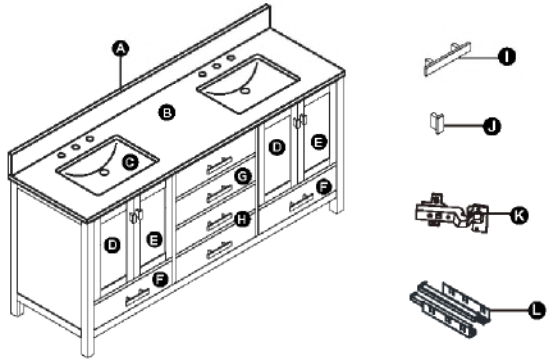

PART #	DESCRIPTION
A	Backsplash
B	Countertop
C	Basin
D	Door (left)
E	Door (right)
F	Bottom drawer
G	Center drawer
H	Double depth drawer
I	Drawer Handle
J	Door Handle
K	Hinge
L	Drawer glides

ATTACHING BACKSPLASH

Following tools are required (not supplied)

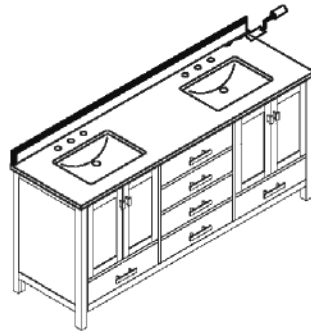
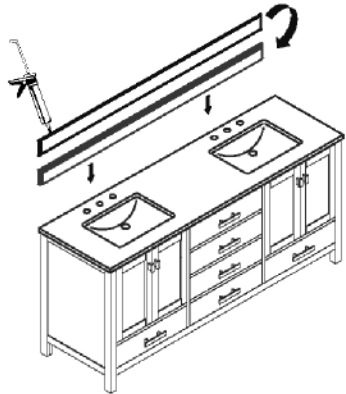

REMOVING / INSTALLING DRAWER

REMOVE



INSTALL

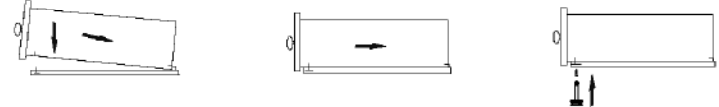

<NOT REQUIRED>

IMPORTANT INSTRUCTION FOR DETACHING COUNTERTOP

Design Element Vanity offers fully assembled vanities so you can enjoy your new bathroom right away. The marble countertop is affixed to the cabinet by sets of screws, no glue is used so it can be separated from the cabinet. If you are concerned about the weight when moving the entire vanity set through a limited access point such as stairwells, or have to replace the countertop, please follow the instruction below to detach and re-attach the countertop from the cabinet. **This process is only recommended when its need. It's NOT required.**

The marble countertop is VERY HEAVY and FRAGILE, be sure to have one or more helper to move the countertop. Before getting started, please prepare for the following:

1. Open work space
2. A large piece of padding or foam to place the countertop onto
3. Screw Driver and somewhere to keep the screws

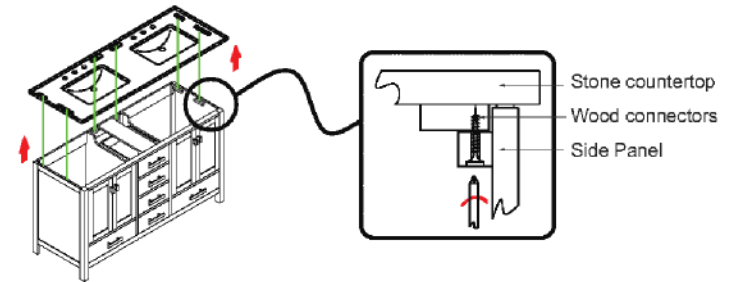

IMPORTANT INSTRUCTION FOR HANDLING COUNTERTOP

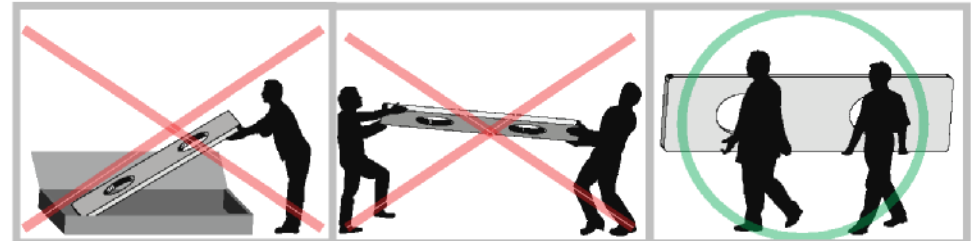

Never lift the countertop flat Never carry the countertop flat Lift the top with long edge facing-up



Lower the counter so that it lays flat on the cabinet, while supporting it from the side and front. Be careful not to catch your fingers under the counter. It is best to lower the counter by supporting from the front as it comes down onto the cabinet.

Reattach the countertop using the wood connectors. (See the instruction above)

MARBLE COUNTERTOP CARE GUIDE

Natural stone is inherently hard and durable, and thus an ideal material for kitchen countertops and bathroom vanities. With proper care and maintenance, your natural stone countertop can last for decades, be it granite, marble, or travertine. Observance of this Care & Maintenance Guide will help you prolong the life of your stone countertop.

Natural Stone Disclaimer

The purchaser acknowledges that natural stones such as Travertine, Marble, Slate, Limestone and Granite are natural stone and have been quarried from all over the world. As natural products, no two pieces of natural stone are exactly alike. They are prone to variations in color, texture, shade and veining, which are not to be considered as a defect.

It is the customer's responsibility to inspect the material before installation. Design Element does not warranty natural stone products for shade coloration, size/ thickness variation, clefting, nor surface finish variation. Absolutely no claim will be accepted for any reason after the material has been installed.

Sealing

All natural stone is porous and should be sealed before use and every 6-12 months, depending on usage to prevent the surface from getting stained or discolored, but will also make the surface more durable against wear and tear.

Avoid Irregular or Excessive Weight on the Stone Surfaces

Stone countertops are tough and durable, but because of its rigidity, will crack under irregular or excessive weight. Do not apply too much weight to any one spot, as this may cause the stone to crack. Do not sit or stand on the countertop surface. Also, be observant of what wall decorations hang over the stone countertops. If the hanging decorations are heavy and fall onto the countertop, the natural stone may crack under the stress.

Regular Stone Care

Natural stone needs to be cleaned regularly to maintain its natural sheen and vitality.

DO'S

- ✓ Clean stone surfaces with warm water, a mild liquid soap like dishwashing detergent, and a non-abrasive cloth.
- ✓ Thoroughly rinse and dry the surface after washing.
- ✓ Blot up spills immediately.

DON'TS

- ✗ Do not use products that contain lemon, vinegar or other acid content that may etch the surface.
- ✗ Do not use abrasive cleaners such as dry cleaners or soft cleansers.
- ✗ Do not use cleaners that contain acids such as bathroom cleaners, grout cleaners, or tile cleaners.
- ✗ Do not apply acetone or any type of paint thinner.
- ✗ Frequent or over-use of soap scum remover could result in dulling the surface of the stone.

kitchensource.com

BATHROOM VANITY OWNER'S MANUAL

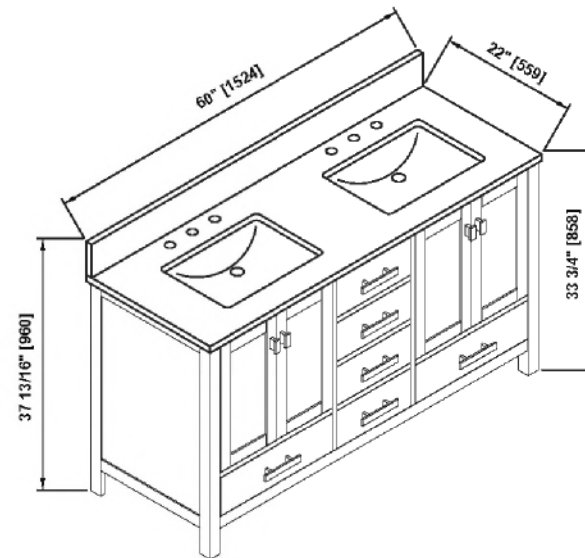

Valentino
COLLECTION | 60-INCH

SKU: V01-60

DIMENSIONS

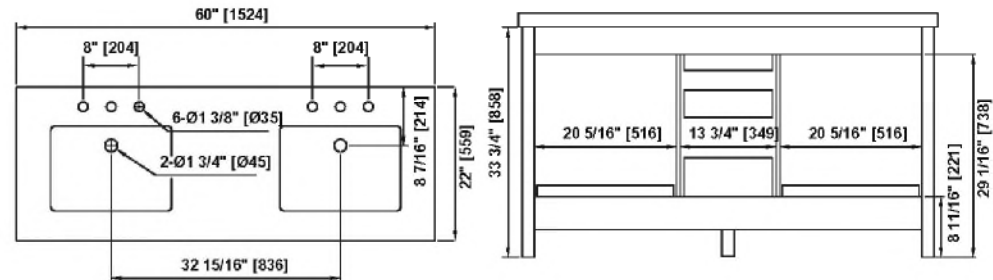

- Carefully read the instructions, before starting the installation.
- This vanity should be installed by an experienced plumber.
- Drain assembly is not supplied.