

# Kräus<sup>®</sup>

INSTALLATION GUIDE

## Kraus Bathroom Accessories

KEA-199\*\*

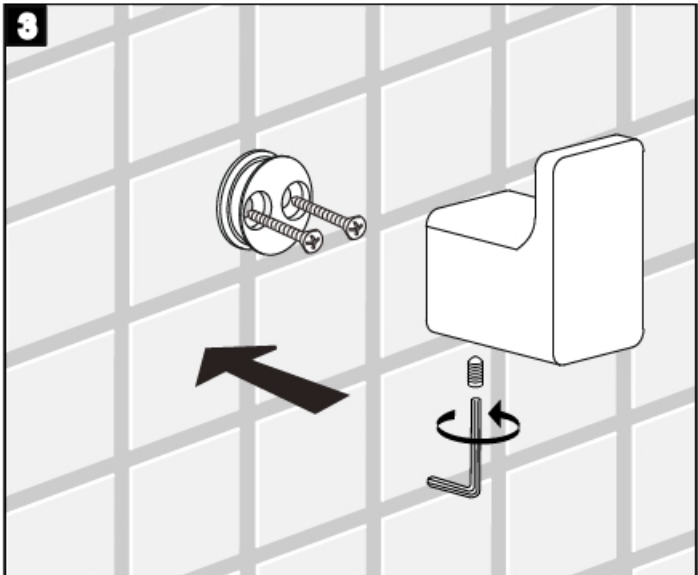
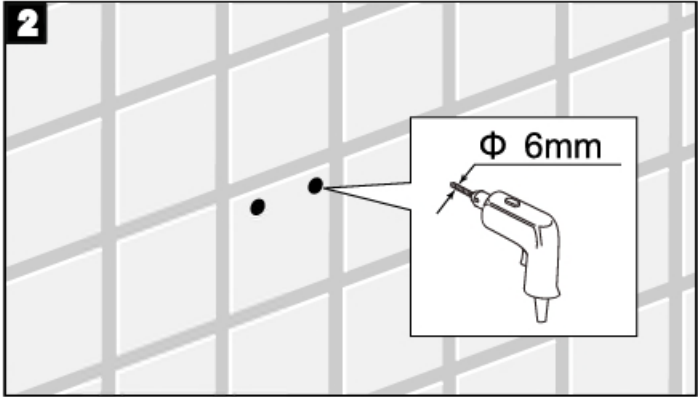
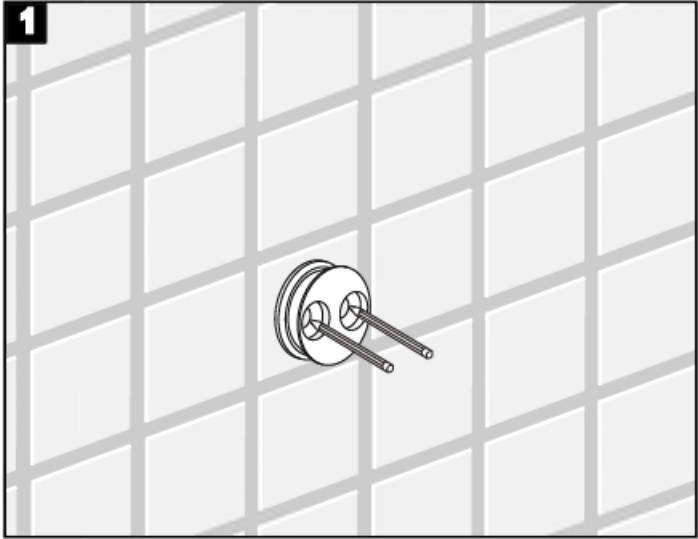
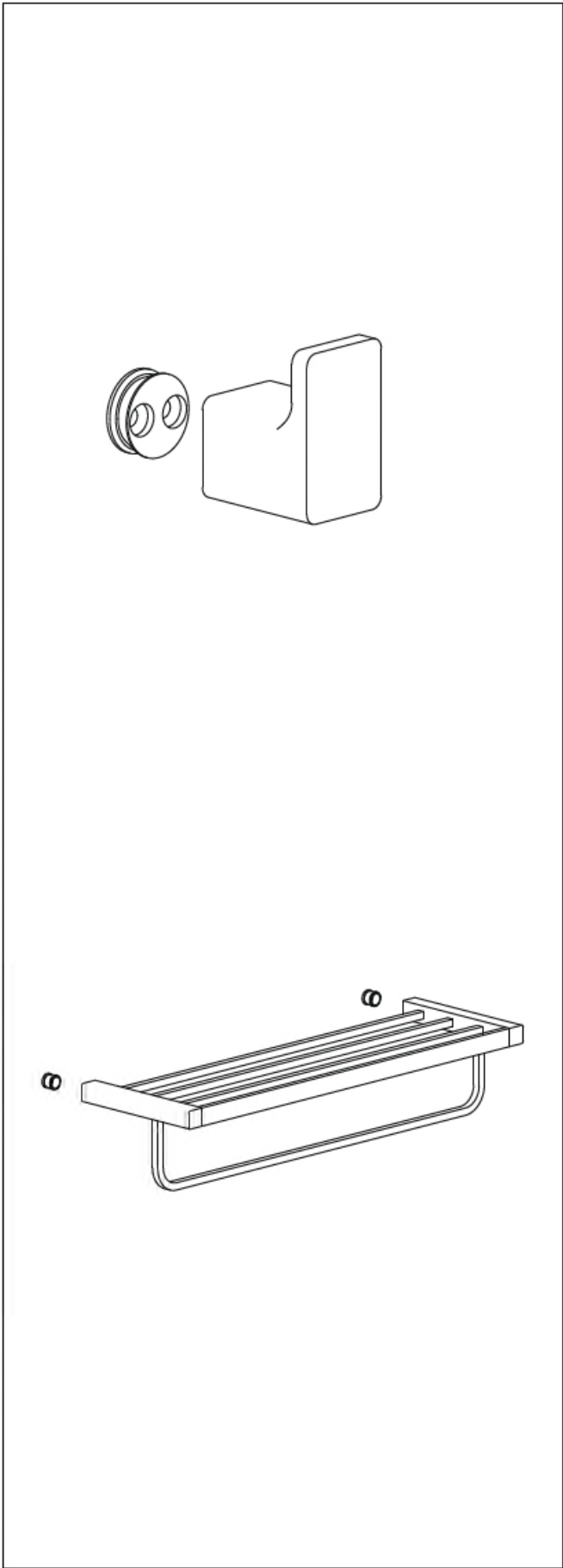

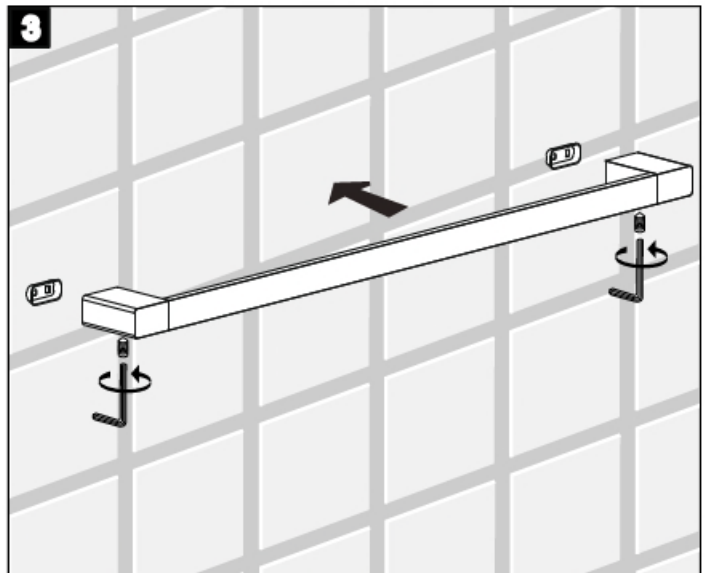
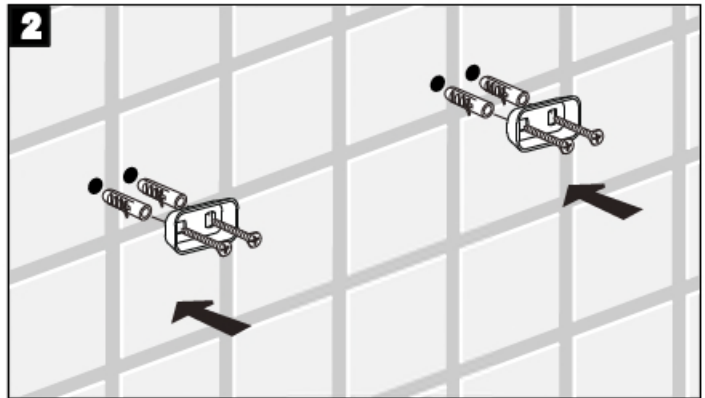
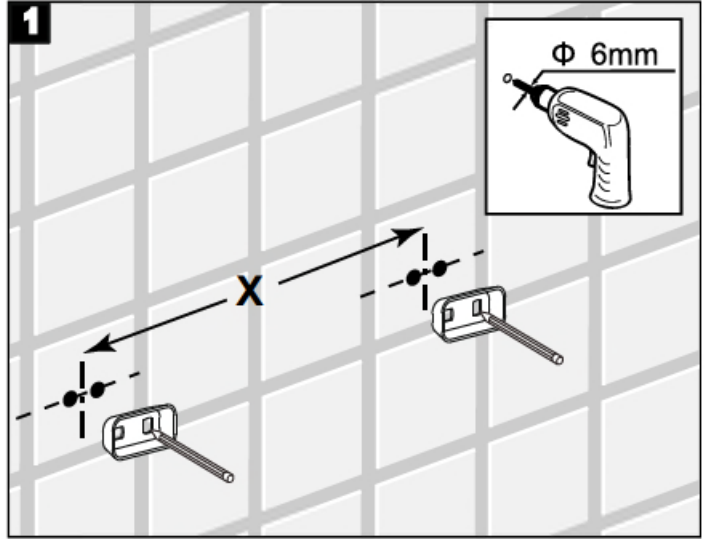
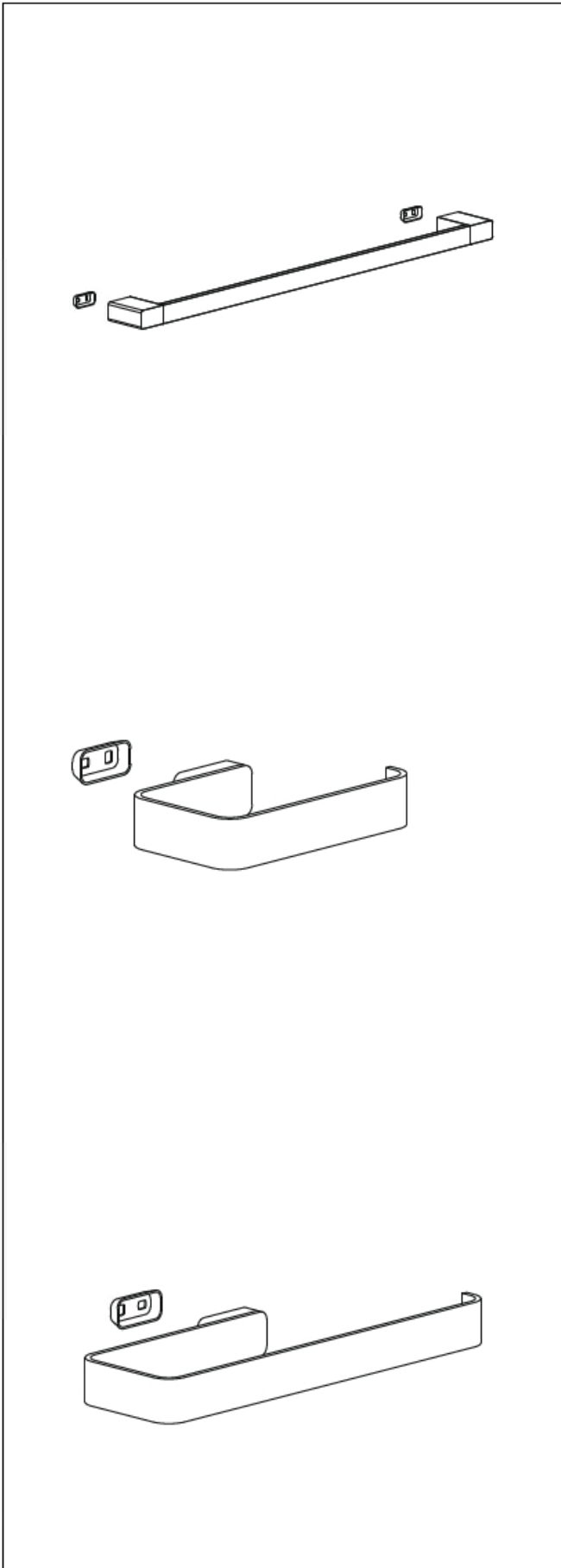

# IMPORTANT

## Register Your Kraus Product

**Activate** Your Warranty

**Access** Premium Customer Support

**Get** Product Information

### Care & Maintenance

\*To keep the product clean & shining, follow the steps below:

- Rinse with clean water & dry with a soft cloth
- Do not clean with soaps, acid, polish, abrasives, or harsh cleaners
- Do not use cloth with a coarse surface
- Unscrew the aerator and clean when necessary

\*This installation manual is subject to change without further notice.



# Kräus®

 [kitchensource.com](http://kitchensource.com)

 1.800.667.8721