



Milan Series Cabinets: 801-V47.3-GW 801-V47.3-WLT 801-V47.3-MGG

Assembly / Installation Instructions for both wall mounting (floating) and freestanding with metal base

Milan Series Metal Bases: 803-B18.1-GW 803-B18.1-MBK 803-B18.1-RGD 803-B18.1-BNK

Important Notes:

This vanity cabinet may be used freestanding, or may be mounted to a wall (floating). If you are using this cabinet as a freestanding unit with the stainless steel base, please follow the instructions on pages 06 - 09 *. If you are using this cabinet as a wall mounted (floating) unit, please refer to pages 01 - 05 *.

Materials for Installation:

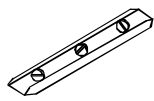

Level

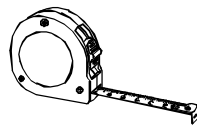

Tape Measuring



Pencil

B pre-attached metal mounting (French Cleat) brackets

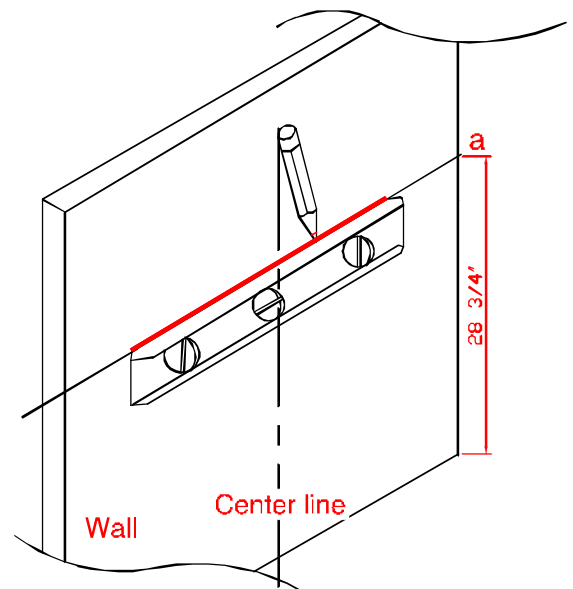
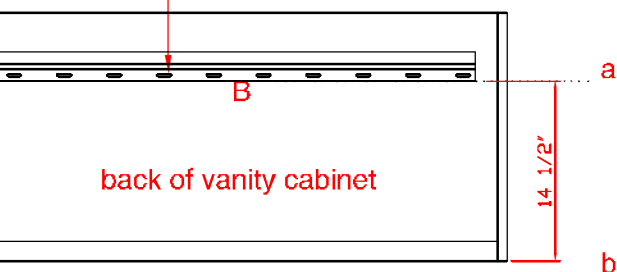

Step 1 Notes:

The metal mounting bracket has been pre-installed to the backside of the cabinet 14 1/2" from the bottom of the cabinet, remove one piece from the back of the cabinet.

Step 2 Notes:

Draw a horizontal line on the wall at your desired height. For this cabinet, most people use a height of 28 3/4"

* For your safety and to achieve the best possible installation of this vanity cabinet, James Martin Vanities always recommends you consult with a professional contractor. Two people are required for the assembly and installation of this vanity cabinet.



Milan Series Cabinets: 801-V47.3-GW 801-V47.3-WLT 801-V47.3-MGG

Assembly / Installation Instructions for both wall mounting (floating) and freestanding with metal base

Milan Series Metal Bases: 803-B18.1-GW 803-B18.1-MBK 803-B18.1-RGD 803-B18.1-BNK

**Materials
for
Installation:**



Stud Finder

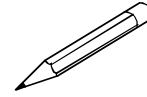

Pencil

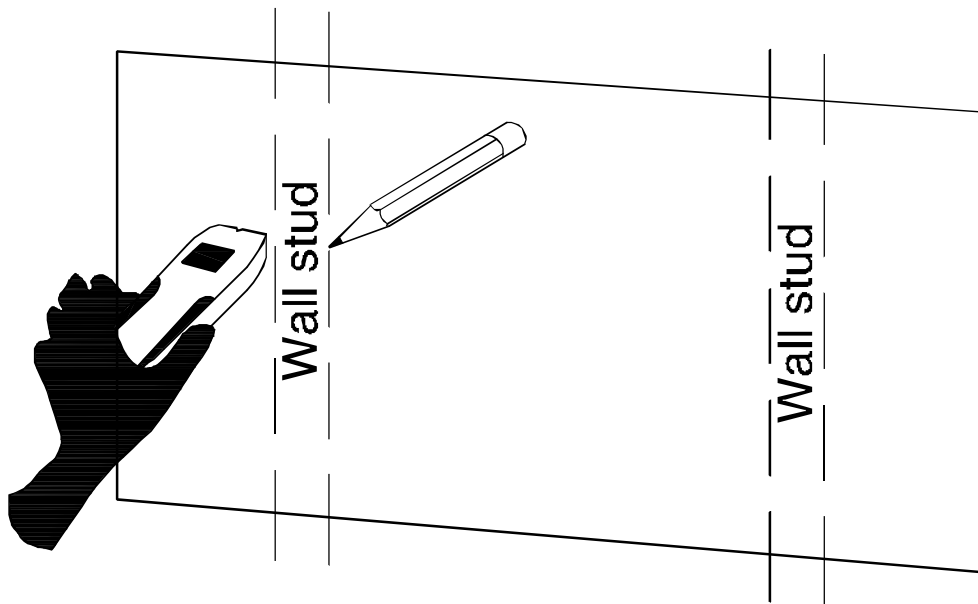

Step 3 Notes:

Locate and mark the position of the wall's interior studs to which you will fasten the metal bracket.

We recommend the use of an electronic stud finder to locate the studs.

(Alternately, you may find studs by listening for a solid sound as you knock on the wall)

Special Note 1:

If the studs in your bathroom do not line up to the mounting location for your vanity, additional wood blocking can be installed between the studs using standard 2 x 4 lumber.

Special Note 2:

Due to the narrow width of this cabinet, you may decide to use drywall anchors if the wall studs are not spaced appropriately.

IMPORTANT:

James Martin Vanities recommended you always consult with professional installers and contractors regarding the correct installation of our products.

Milan Series Cabinets: 801-V47.3-GW 801-V47.3-WLT 801-V47.3-MGG

Assembly / Installation Instructions for both wall mounting (floating) and freestanding with metal base

Milan Series Metal Bases: 803-B18.1-GW 803-B18.1-MBK 803-B18.1-RGD 803-B18.1-BNK

Materials for Installation:

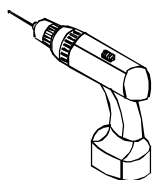

Drill

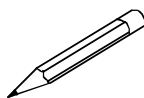

Pencil



Hammer

A=11PCS Screws for Bracket Ø4*40mm

B=1PC Metal Bracket (42 1/8" 1070mm)

C=11PCS Drywall Anchors (optional) Ø8*38mm

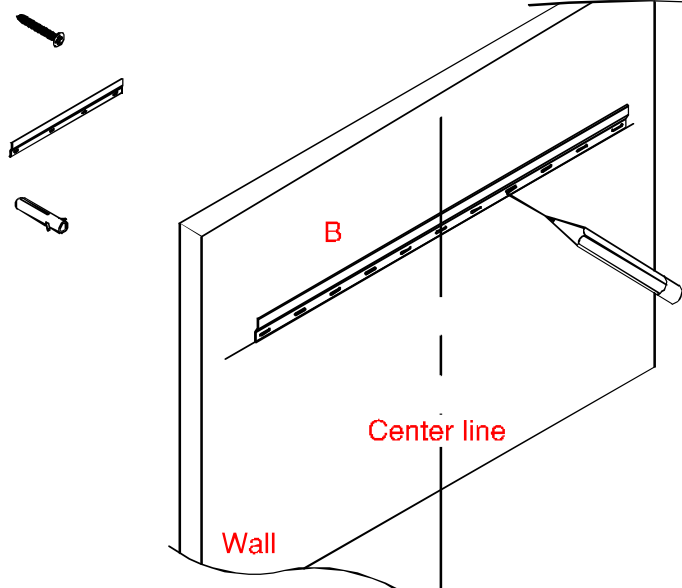

Step 4 Notes:

After you have located the wall studs, position the metal bracket so the holes align with the center points of the studs. Mark these positions with a pencil.

Step 5 Notes:

Drill holes for the screws in the positions you have marked with the pencil. Drill the holes' depth no less than 1 1/2", insert "C" to the holes by using hammer if wall studs are not in the correct positions.

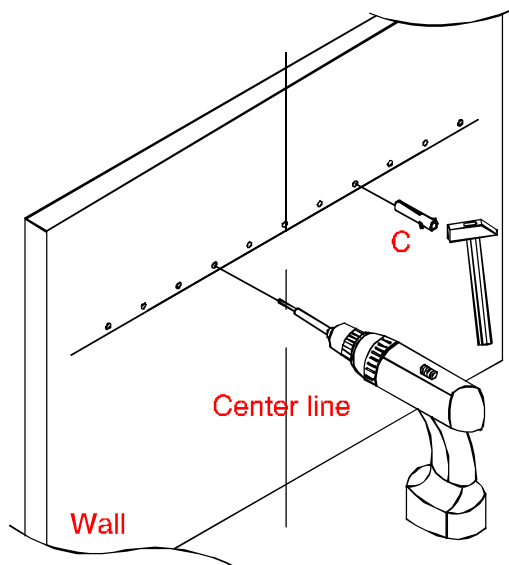

Milan Series Cabinets: 801-V47.3-GW 801-V47.3-WLT 801-V47.3-MGG

Assembly / Installation Instructions for both wall mounting (floating) and freestanding with metal base

Milan Series Metal Bases: 803-B18.1-GW 803-B18.1-MBK 803-B18.1-RGD 803-B18.1-BNK

**Materials
for
Installation:**

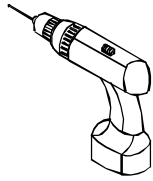

Drill

Step 6 Notes:

Attach the metal bracket **B** to the Wall using the screws **A** included in the red hardware bag.

*Use hardware **C** (drywall anchors) if wall studs are not in the correct positions.

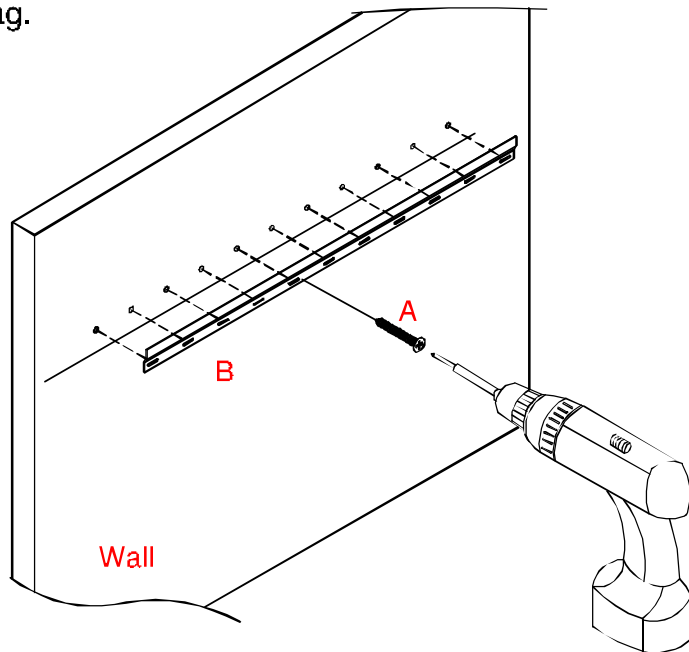

Step 7 Notes:

Hang the cabinet on the metal bracket (Figure B)

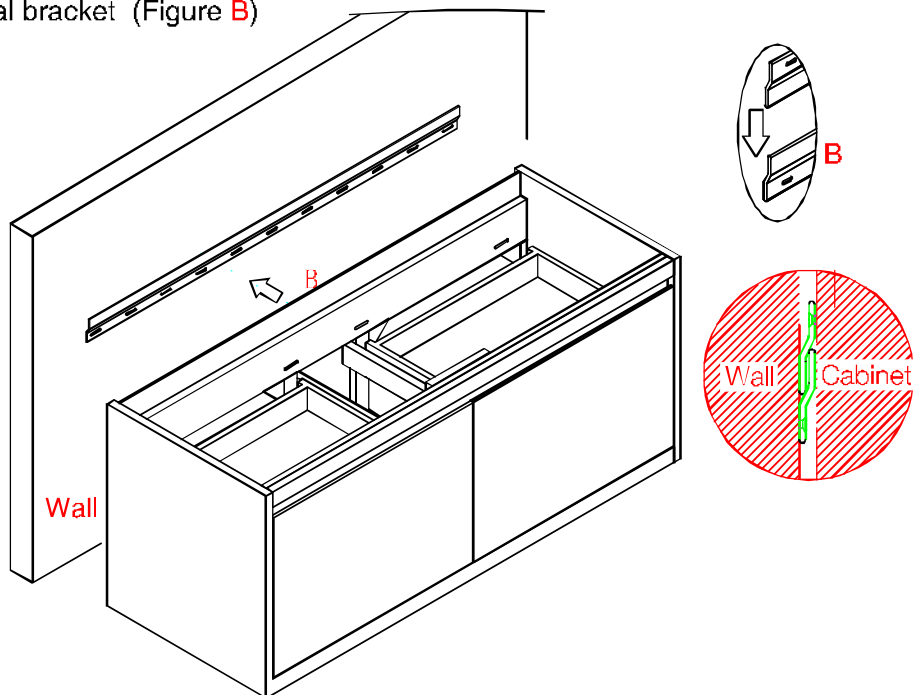

Milan Series Cabinets: 801-V47.3-GW 801-V47.3-WLT 801-V47.3-MGG

Assembly / Installation Instructions for both wall mounting (floating) and freestanding with metal base

Milan Series Metal Bases: 803-B18.1-GW 803-B18.1-MBK 803-B18.1-RGD 803-B18.1-BNK

Materials
for
Installation:

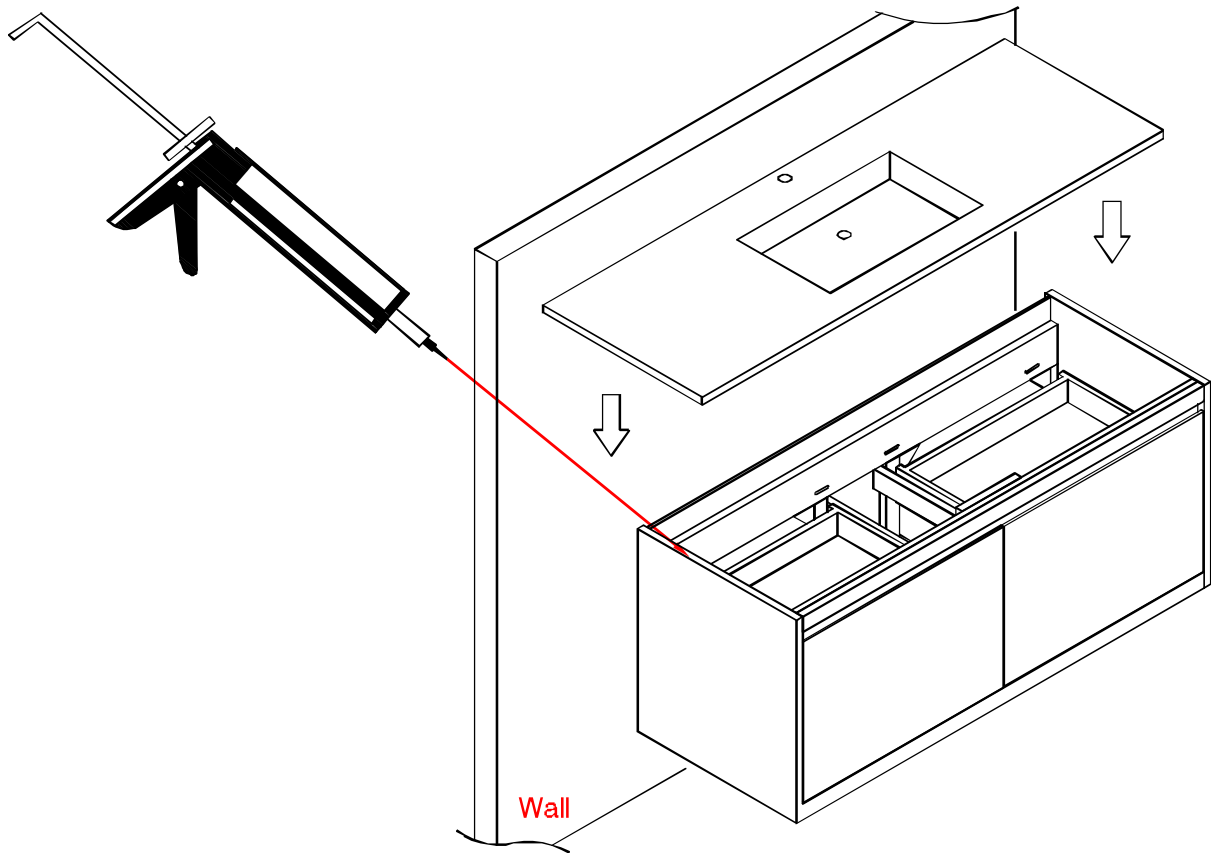
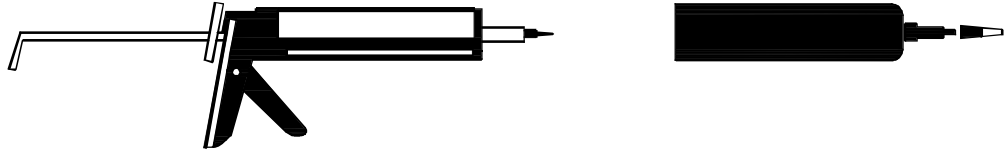

Step 8 Notes:

Properly align and secure the countertop to the cabinet with high quality adhesive.

Milan Series Cabinets: 801-V47.3-GW 801-V47.3-WLT 801-V47.3-MGG

Assembly / Installation Instructions for both wall mounting (floating) and freestanding with metal base

Milan Series Metal Bases: 803-B18.1-GW 803-B18.1-MBK 803-B18.1-RGD 803-B18.1-BNK

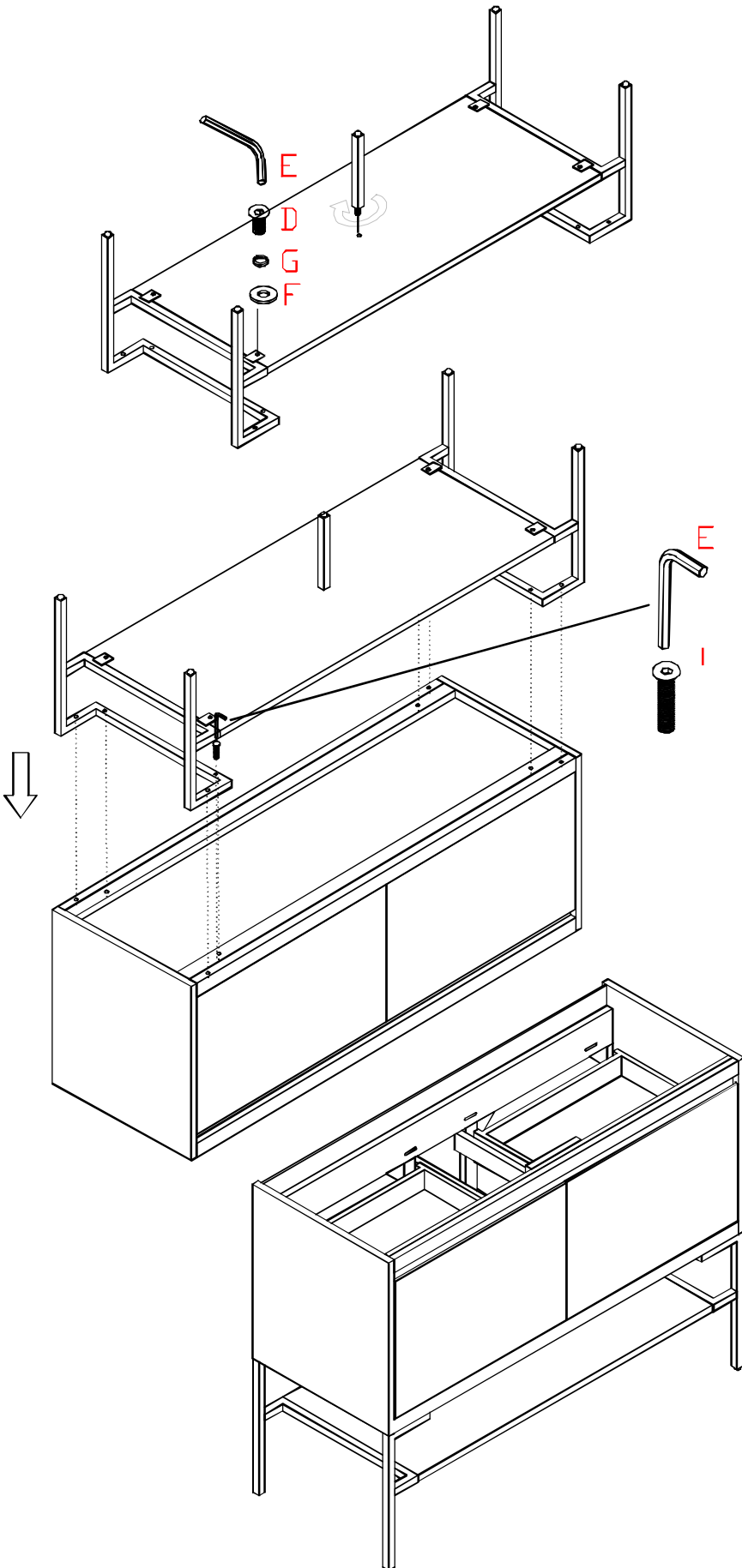

* For your safety and to achieve the best possible installation of this vanity cabinet, James Martin Vanities always recommends you consult with a professional contractor. Two people are required for the assembly and installation of this vanity cabinet.

Warning: To prevent accidental tip-over of these cabinets, you must follow these steps.

Step 1b Notes:

Place the vanity cabinet upside down on a blanket or other soft material, to prevent scratching.

Step 2b Notes:

Attach the metal bolts (D) to the bottom of the vanity cabinet. Secure the bolts by turning the Allen Wrench (E)

Step 3b Notes:

Once the metal base has been safely and securely attached to the vanity cabinet, you may return the cabinet to the upright position.

D = 4PCS Bolts 1/4" x 1/2"



E = 1PC Allen Wrench (#4)



F = 4PCS Flat Washer 1/4" x 5/8"



G = 4PCS Spring Washer 1/4"



I = 8PCS Bolts 1/4" x 1"



Milan Series Cabinets: 801-V47.3-GW 801-V47.3-WLT 801-V47.3-MGG

Assembly / Installation Instructions for both wall mounting (floating) and freestanding with metal base

Milan Series Metal Bases: 803-B18.1-GW 803-B18.1-MBK 803-B18.1-RGD 803-B18.1-BNK

Materials for Installation:

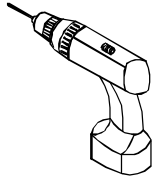

Drill

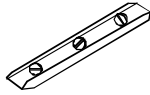

Level

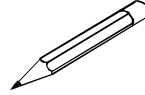

Pencil

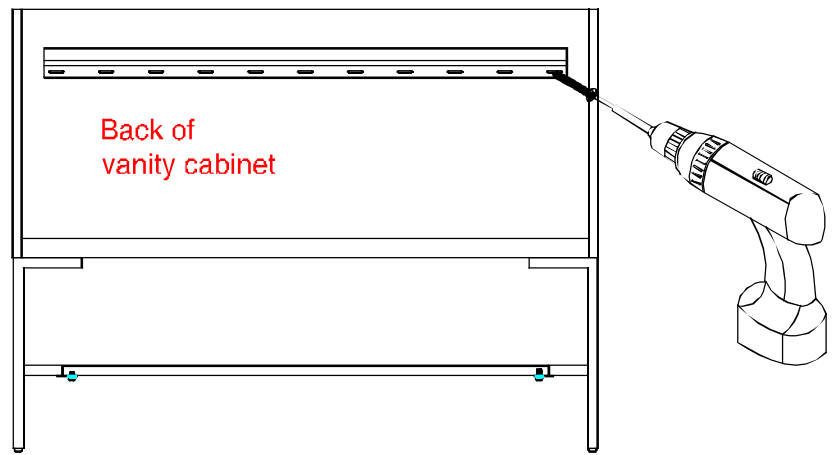

Step 4b Notes:

Remove the pre-attached metal mounting (French Cleat) brackets.

Step 5b Notes:

Put the cabinet against the wall, mark the positions with a pencil through the pre-drilled holes on the back rail.

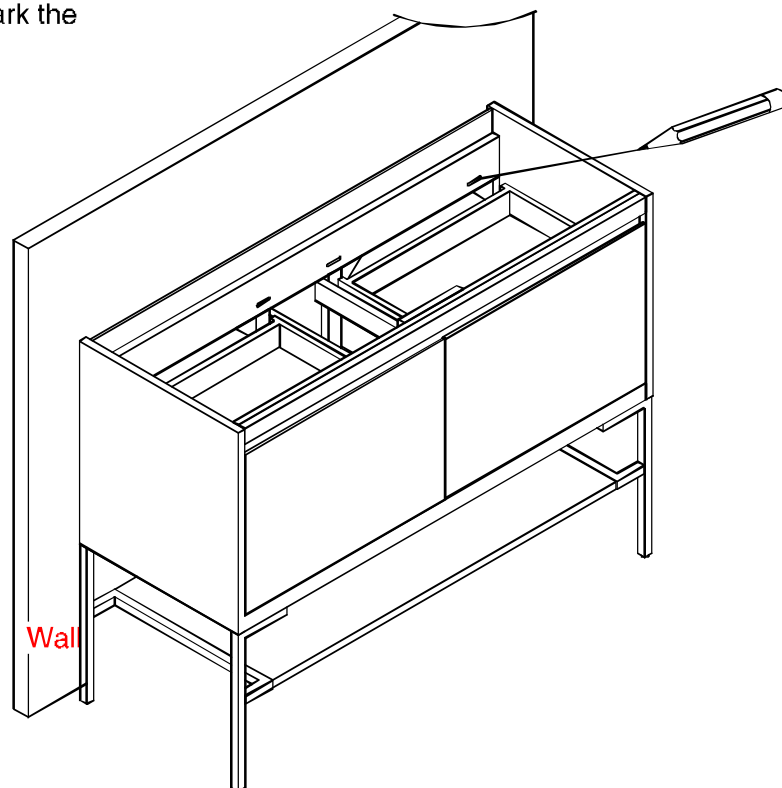



Milan Series Cabinets: 801-V47.3-GW 801-V47.3-WLT 801-V47.3-MGG

Assembly / Installation Instructions for both wall mounting (floating) and freestanding with metal base

Milan Series Metal Bases: 803-B18.1-GW 803-B18.1-MBK 803-B18.1-RGD 803-B18.1-BNK

Materials for Installation:

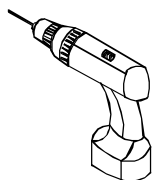

Drill



Hammer

Step 6b Notes:

Drill holes for the screws in the positions you have marked with the pencil.
 Drill the holes' depth no less than 1 1/2", insert hardware **C** (drywall anchors) to the holes by using hammer if wall studs are not in the correct positions.

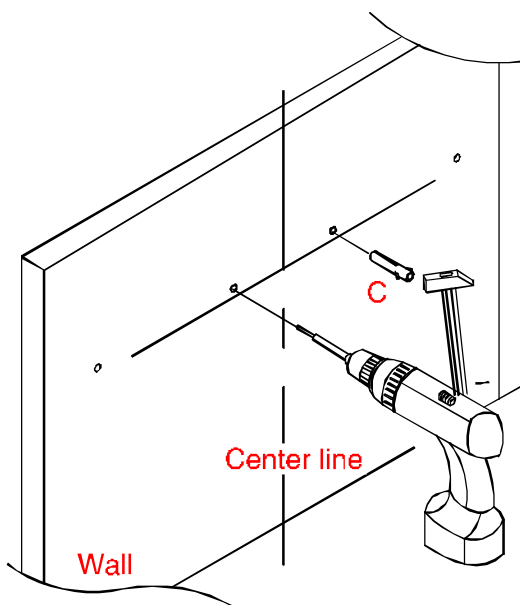

C=4PCS drywall anchors (optional) Ø8*38mm

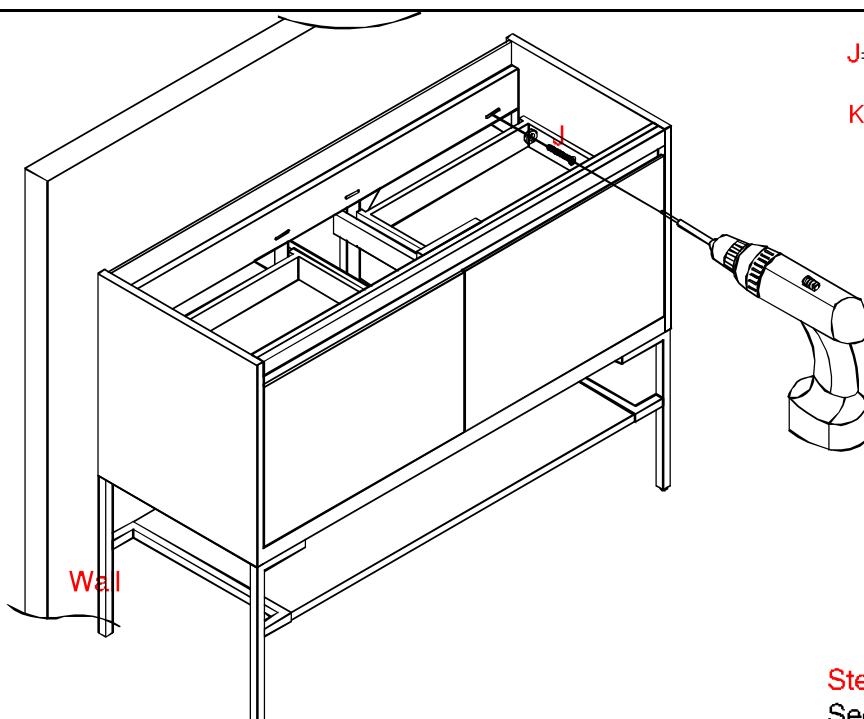

J=4PCS Screw Ø4*60mm



K=4PCS Flat Washer Ø11mm



Step 7b Notes:

Secure the cabinet to the wall using hardware **J** (screws) and Flat Washer **K** for wall studs.

Milan Series Cabinets: 801-V47.3-GW 801-V47.3-WLT 801-V47.3-MGG

Assembly / Installation Instructions for both wall mounting (floating) and freestanding with metal base

Milan Series Metal Bases: 803-B18.1-GW 803-B18.1-MBK 803-B18.1-RGD 803-B18.1-BNK

Materials
for
Installation:

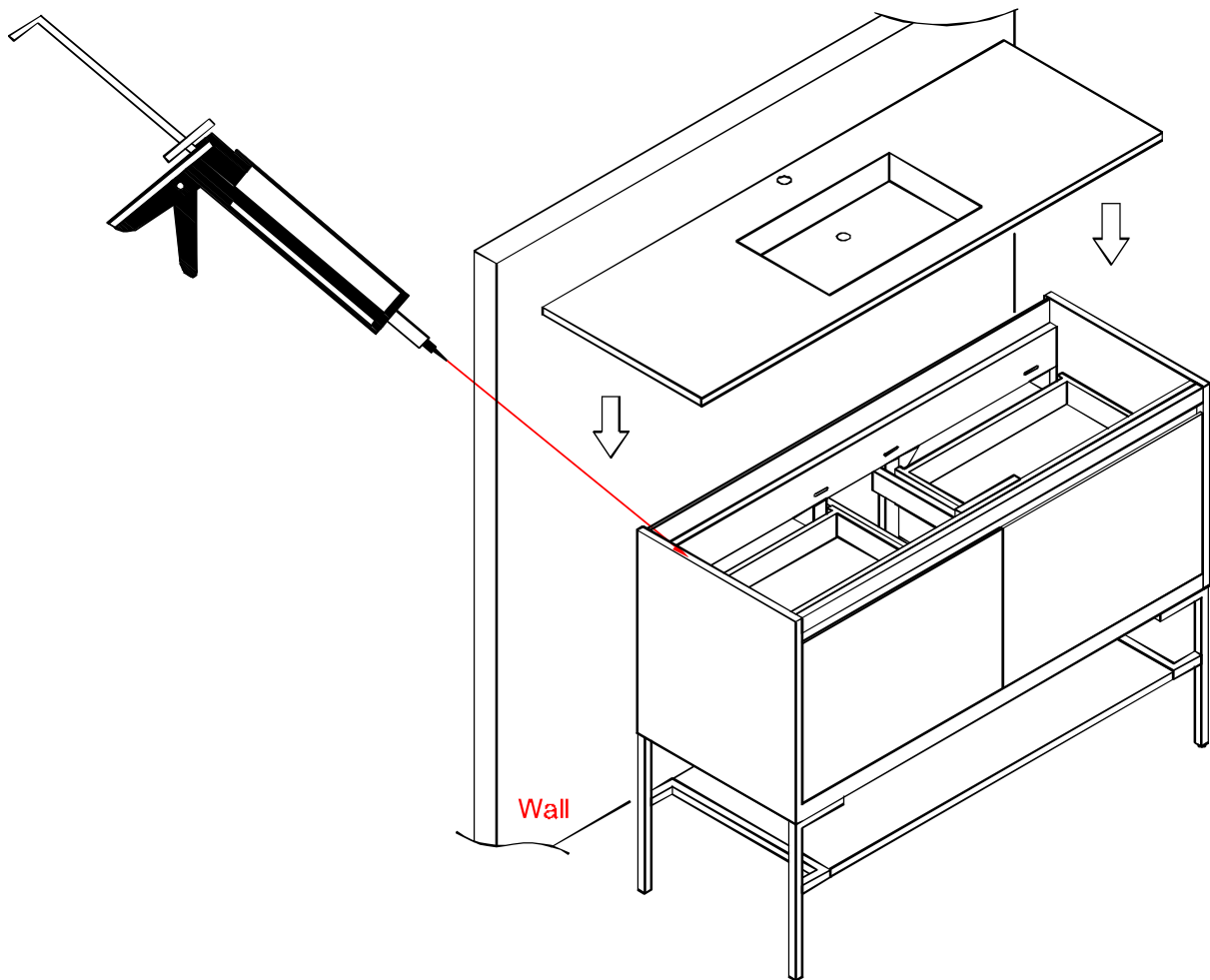
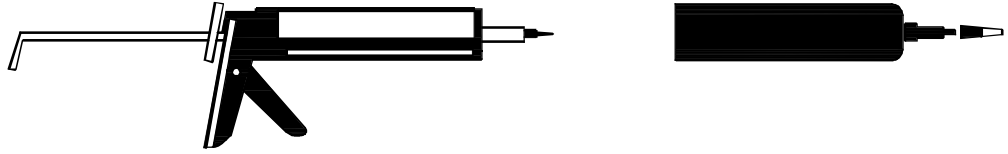

Step 8b Notes:

Properly align and secure the countertop to the cabinet with high quality adhesive.