

## MODEL NUMBER

VG03028



## VIGO LENOX cFiber® WALL MOUNT BATHROOM FAUCET

### DIMENSIONS

Faucet Height	10 3/8" [261.6mm]
Spout Reach	6 3/8" [160.5 mm]
Spout Height	7" [176.8mm]
Hole Diameter	1 3/8" [35 mm]
Water Supply Connection	3/8" [9.5 mm]

### FEATURES

- Seven Layer Coated Finish
- Fingerprint Resistant
- cFIBER® Technology
- Precise Engineering
- 1.2 gallons per minute
- Single-hole Installation
- Reinforced PEX Supply Lines
- Limited Lifetime Warranty

### RECOMMENDED TOOLS



Adjustable Wrench



Eye Protection



Basin Wrench



Safety Gloves

### PACKING LIST

- Faucet
- Supply Lines
- Allen Key (2 mm)
- Plumbers Tape

### NOTE

Residue from liquid soap and cleaning products may cause damage, so it is advised to rinse with clean water after use.

If the surface of the product is already damaged, effects from cleaning materials may cause further damage. Hard water may damage finish.

## MODEL NUMBER

VG03028

## PACKAGE CONTENTS

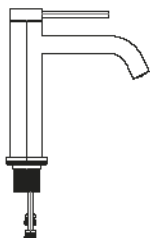

Faucets

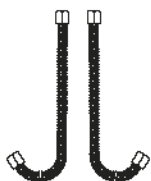

Two Flexible Hoses

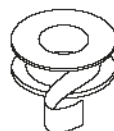

Plumbers Tape



Allen Key (2mm)

## WARNING



Damage caused by improper installation/ maintenance will not be covered by our guarantee and/ or warranty.



Usage over max PSI will damage internal components. (Max 60 PSI) (Min 30 PSI)



Always wear safety equipment.

## CERTIFICATE & WARRANTY

cUPC, NSF-61, NSF 372, AB1953, CEC, and WaterSense certified by IAPMO R&T, ADA compliant

All VIGO Bathroom Faucets have a Limited Lifetime Warranty



## TROUBLESHOOTING

#1	Leak from handle	1A: Cartridge unseated 1B: Cartridge defective	1A: Remove cartridge from housing, wash thoroughly with hot water and reseat in housing. 1B: Contact VIGO Product Support for replacement.
#2	Insufficient flow rate	2: Clog in supply hose / line	2: Remove supply lines and flush lines.
#3	Leak at connection points	3A: Flexible hose leaking at connection point 3B: Washer defective	3A: Tighten hoses. If this does not resolve the issue, remove the flexible hose and rethread, checking to make sure the connection is secure. Make sure to use pipe tape 3B: Remove supply line and check the status of the washer. If torn, washer must be replaced for a secure, non-leaking connection.
#4	Loose faucet body	4: Mounting hardware became loose	4: From under the counter, use an adjustable wrench and tighten the mounting hardware. Make sure the faucet is perpendicular to the counter.
#5	Loose handle	5: Set screw has become loose	5: Take off hot/cold cover on handle. This will give you access to the screw that connects the handle to the cartridge. Using either an allen key or a flat head screw driver, tighten the screw so handle has firm connection to cartridge.

MODEL NUMBER

VG03028

## MEASUREMENTS

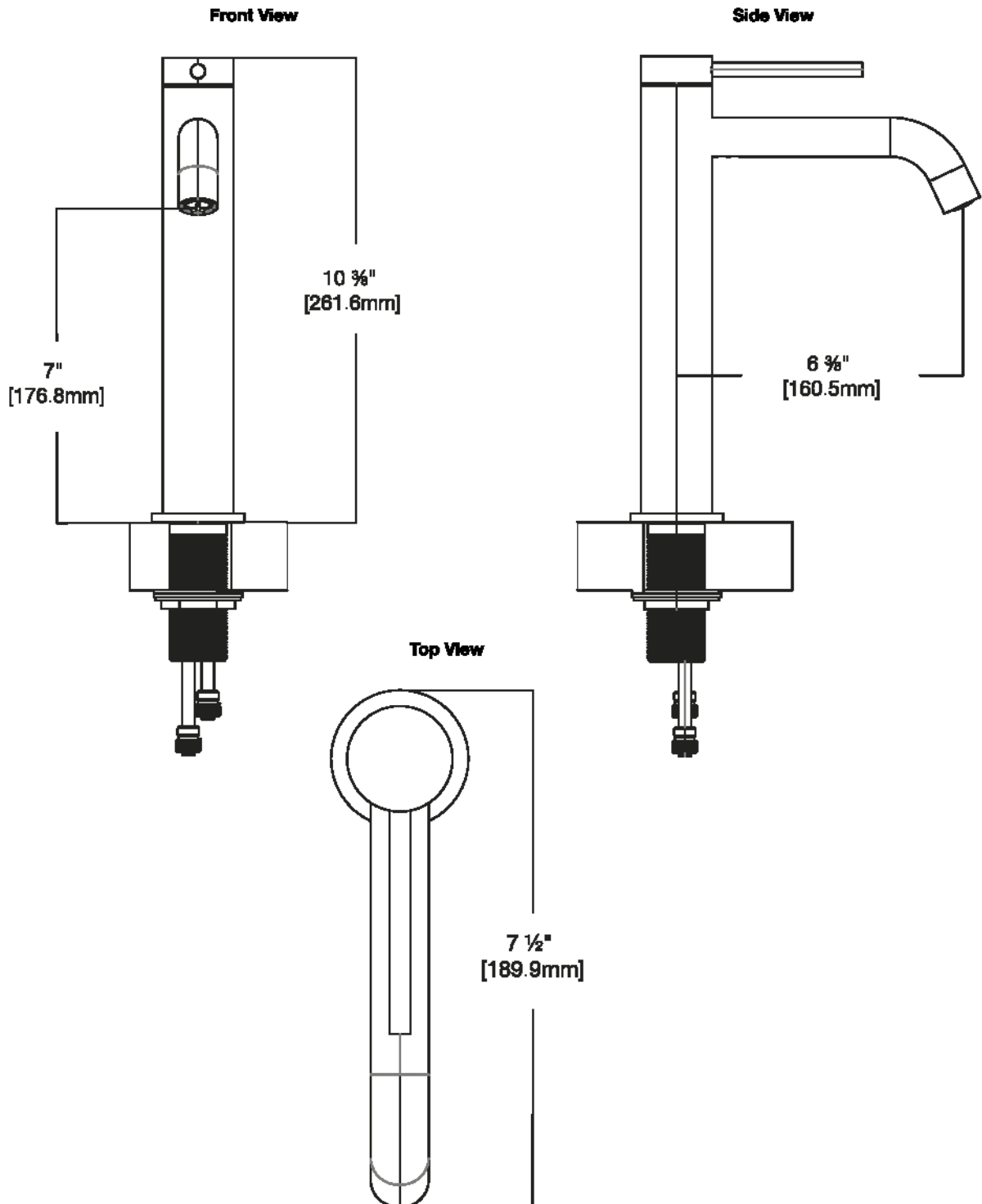

**MODEL NUMBER**

VG03028

**PARTS**

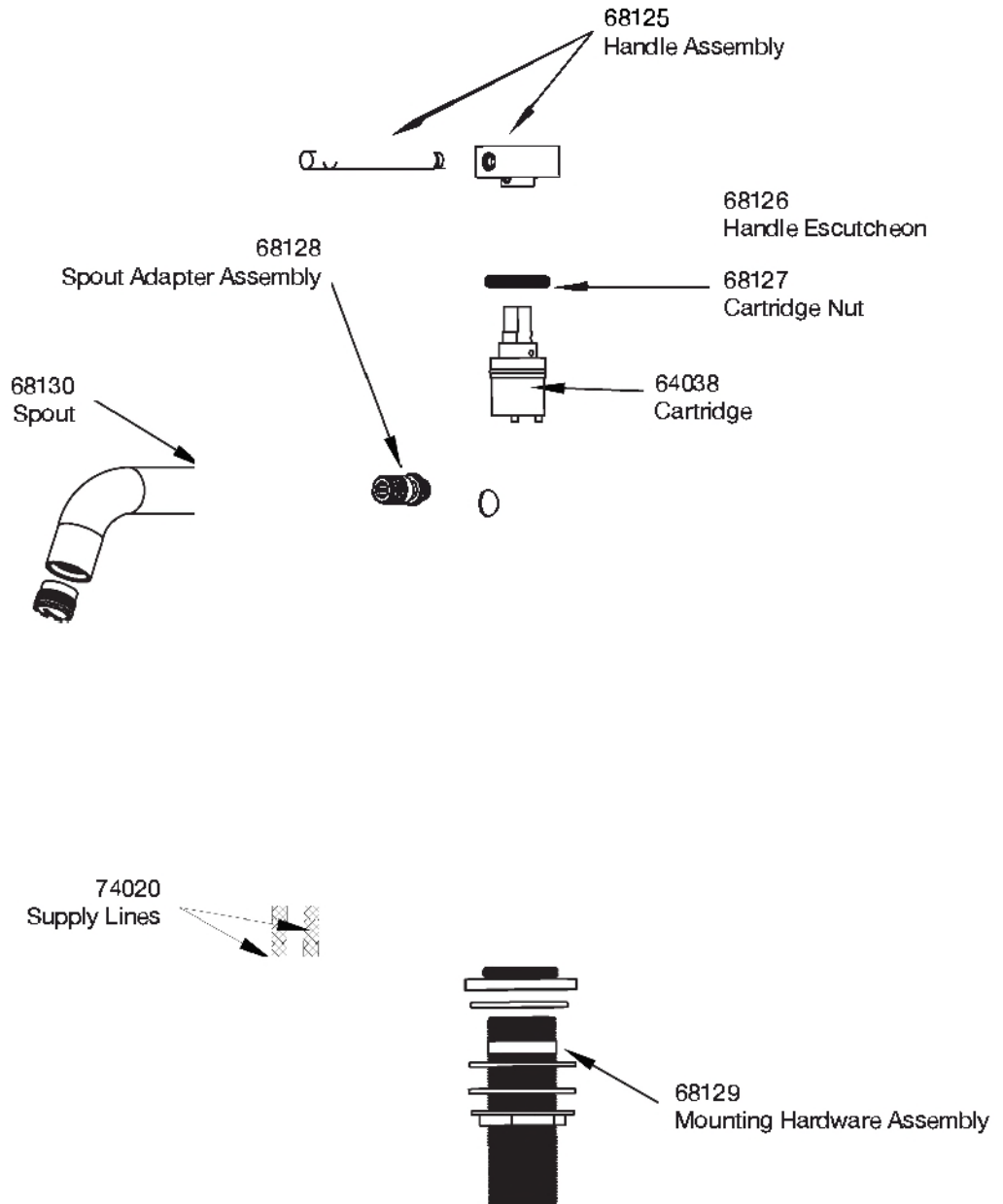

MODEL NUMBER

VG03028

## INSTALLATION

**NOTE:** Installation must be performed by a qualified, licensed plumber. After installation is complete, remove the aerator. Turn on the water supply valves and allow both hot and cold water to run at least one minute each. While water is running, check for leaks, especially at hook-ups to supply lines. Tightening nuts slightly will stop any minor leaks.

### STEP 1

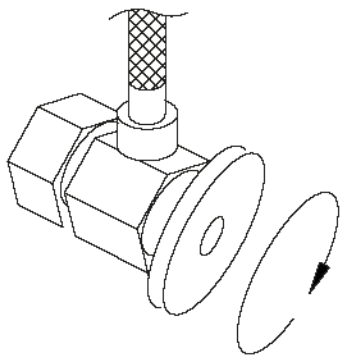

Step 1: Shut off water supply. Remove old faucet and flexible hoses. Clean sink surface in preparation for the new faucet. Flush water connection at home to make sure no debris is stuck in the line.

### STEP 2

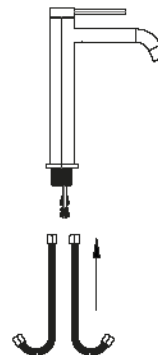

Step 2: Connect flexible hoses to the brass pipes.

### STEP 3

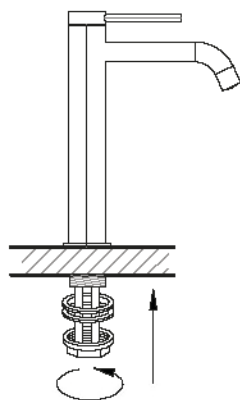

Step 3: Place new faucet in the position on the countertop. From under the sink, put rubber washer, metal ring, brass nut onto threaded pin. Tighten nut.

### STEP 4

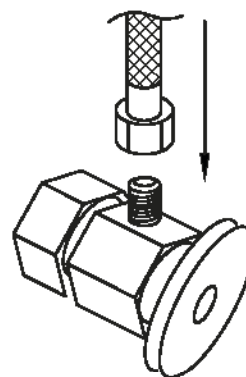

Step 4: Connect female end of flexible hoses to the cold and hot water supply.

Modern faucets and showers consist of very different materials to comply with the needs of the market with regard to design and functionality. To avoid damage and reclamations, it is necessary to consider certain criteria when cleaning. Be sure to avoid using abrasive materials while cleaning VIGO products.

## REGISTER YOUR PRODUCT

IN ORDER TO ACTIVATE YOUR WARRANTY  
YOU MUST REGISTER YOUR PRODUCT

ACTIVATE NOW

## CLEANING INSTRUCTIONS FOR FAUCETS AND SHOWERS

Please follow the instructions on your cleaning materials. In addition, pay attention to the following points:

- Clean the faucets and showers as needed and when required.
- The amount of cleaning product needed and the time the cleaner needs in order for effective cleaning to take place should be adjusted according to products; cleaning product should not be left on VIGO product longer than necessary.
- Clean regularly to prevent calcification.
- When using spray cleaner, spray first onto a cloth or sponge - never directly spray onto the sanitary tapware as drops could enter openings and gaps and cause damage.
- After cleaning, rinse thoroughly with clean water to remove any cleaner residue.
- Recommended cleaning solution for hard water and soap scum is to use 50/50 water and vinegar solution.



NEVER SPRAY  
DIRECTLY  
ON TAPWARE



SPRAY ONTO  
SPONGE/ CLOTH



CLEAN  
REGULARLY



RINSE THOROUGHLY  
WITH CLEAN WATER

## CLEANING MATERIAL FOR FAUCETS AND SHOWERS

Acids are necessary ingredients of cleaning materials for removing lime, however, please pay attention to the following points when cleaning faucets and showers:

- Only use cleaning materials that are explicitly provided for this type of application.
- Never use cleaning materials that contain hydrochloric, formic or acetic acid, as they cause considerable damage.
- Phosphoric acid is also restricted as it can cause damage to the finish.
- Never mix any cleaning material with another.
- Never use cleaning materials that have an abrasive effect, such powdered and industrial cleansers, scouring pads or micro fiber cloths.

~~Hydrochloric~~

~~Formic~~

~~Acetic Acid~~

~~Phosphoric~~

# BATHROOM FAUCET LIMITED LIFETIME WARRANTY

# VIGO

**VIGO INDUSTRIES, LLC ("VIGO")  
EFFECTIVE JANUARY 1, 2019**

---

VIGO offers the following limited warranty on each of its BATHROOM FAUCET Products\* (the "Product"). This warranty extends only to the original purchaser/end-user for personal household use and is not transferrable. For commercial use, additional limitations apply.

VIGO warrants hoses and all mechanical components to be free from defects in workmanship and materials under normal household use for the period of ONE (1) year from the initial date of purchase by the purchaser/end-user, contractor, or builder from VIGO or an authorized VIGO Dealer.

VIGO warrants the cartridge to be free from defects in workmanship and materials under normal household use for the period of FIVE (5) years from the initial date of purchase by the purchaser/end-user, contractor, or builder from VIGO or an authorized VIGO Dealer.

VIGO warrants the finish of the Product to be free from defects in workmanship and materials under normal household use for the lifetime of the product by the original purchaser/end-user.

Subject to the Warranty provisions below, any product reported to VIGO or an authorized dealer as being defective within the warranty period will receive replacement parts and/or troubleshooting assistance to correct the issue. If a replacement unit is deemed necessary by VIGO, the replacement will be made with the same model (or with a product of equal value). This warranty extends to the original purchaser/end-user and is not transferrable to a subsequent owner. Neither the distributor, authorized dealer, nor any other person has been authorized to make any affirmation, representation, or warranty other than those contained in this warranty. Products sold in "as-is" condition, closeouts, discounted, resale, return purchases or purchases made through non-authorized dealers are not covered under the terms of this warranty. Any affirmation, representation, or warranty other than those contained in this warranty shall not be enforceable against VIGO or any other person. VIGO reserves the right to modify this warranty at any time with the understanding that such modifications will not alter the warranty conditions applicable at the time of sale for the products in question.

## LIMITATIONS

---

This warranty shall not apply to instances of incorrect operating procedures, breakages, or damages caused by fault through improper installation, carelessness, abuse, misuse, misapplication, improper maintenance, or alteration of the Product, as well as damage due to hard water, chemical or natural corrosion, accident, fire, flood, an act of God, or any other casualty. When cleaning, handling, and maintaining the Product, avoid using abrasive cleaners, steel wools, and harsh chemicals as these will scratch, damage and/or dull the product and/or finish and void this warranty. The owner/end-user of the Product covered by the present warranty is entirely responsible for all labor costs, proper installation and any applicable plumbing or electrical wiring. VIGO neither installs nor supervises installation, nor hires contractors for this purpose. VIGO cannot be held responsible for any default, breakage, or damages caused thereby or resulting thereof, either directly or indirectly. The owner/end-user must provide requested images, photos, videos of the Product as described in the installation guide so that VIGO can properly troubleshoot and execute the warranty specified herein. All repair expenses and labor are the responsibility of the owner/end-user. This warranty does not apply to Products that have not been installed or operated in accordance with instructions supplied by VIGO and all applicable rules, regulations, and legislation pertaining to such installations. This warranty does not apply unless the VIGO Product is installed by a fully insured, licensed professional. VIGO strongly recommends that such licensed professional have experience in the installation of bathroom and kitchen products. Installation of certain products, including but not limited to glass products (i.e. shower doors and glass sinks) by an inexperienced person may result in glass breakage, and consequently may cause personal injury or death. VIGO is not liable for personal injuries or deaths to any persons or for any direct special, incidental or consequential damage, loss of time, loss of profits, inconvenience, incidental expenses, labor or material charges, or other costs resulting from the use of the Product or equipment pertaining to the application of the present warranty, or resulting from the removal or replacement of any product or element or part covered by this warranty.

EXCEPT AS OTHERWISE PROVIDED ABOVE, VIGO MAKES NO WARRANTIES, EXPRESSED OR IMPLIED, INCLUDING WARRANTIES OF MERCHANTABILITY AND FITNESS FOR A PARTICULAR PURCHASE OR COMPLIANCE WITH ANY CODE. VIGO cannot be held liable for any amount over and above the purchase price paid for the Product by the owner/end-user, contractor, builder, or other installation professional.

## COMMERCIAL LIMITATIONS

---

In addition to the above conditions and limitations, the warranty period for the products installed for commercial applications or used in commercial ventures is ONE (1) year from the initial date of purchase by the owner/end-user, contractor, or builder from an authorized dealer. VIGO is not responsible for loss of use or profit under any circumstances. If the product is used as a display, the warranty period begins when the product is placed on display. This warranty gives the owner/end-user specific legal rights. The owner/end-user may also have other rights which may vary from one state or province to another.

## WARRANTY CONDITIONS

---

In order to obtain the warranty provided, please contact the VIGO Product Support Department during normal business hours at option 2 or via email at [VIGO@kitchensource.com](mailto:VIGO@kitchensource.com). VIGO will assist with troubleshooting and provide replacement parts as described above when the following conditions have been met: the failure is of the nature or type covered by the warranty; the user has informed VIGO of the nature of the problem during the warranty period; conclusive evidence (e.g. proof of purchase and images, video, etc.) is provided to the foregoing by the user proving that the failure occurred or was discovered within the warranty period. VIGO's warranty obligation shall be discharged upon tender of replacement parts or product replacement. The customer's refusal to accept the tender terminates VIGO's warranty obligations.

\*Certain models are pending approval.

Certification may be ended by VIGO or certification agencies without notice.