

BEFORE YOU BEGIN YOUR INSTALLATION



Shut off water supply



Flush hot and cold water supply lines



Required tools



Installation by License Professional Plumber



Flush the water pipe before installation



Drawings are for reference only



Do not disassemble the body

FAUCET INSTALLATION

1

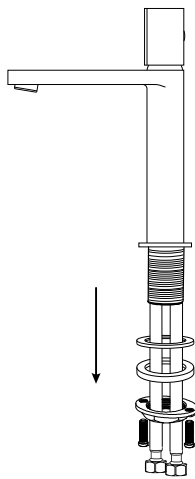

Remove the washer and mounting nut.

2

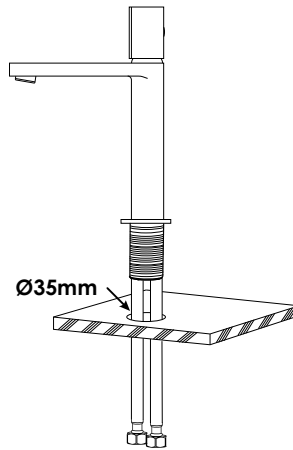

Ensure there is a Ø35mm through-hole on the counter. Position and insert faucet into faucet countertop hole.

3

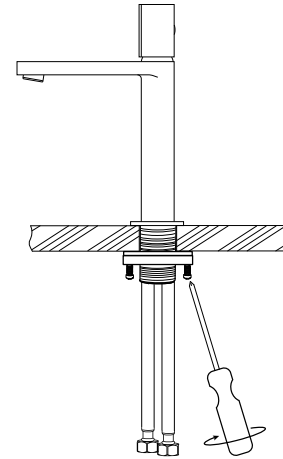

Tighten the mounting nut with the screws until faucet is firmly secure.

4

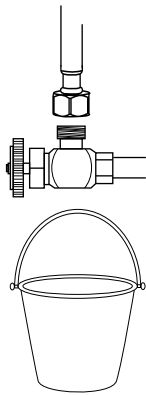

Before connecting supply hose, flush supply valves to clear any debris. Place a bucket underneath valves and run water for 5 to 10 seconds. Turn water off.

5

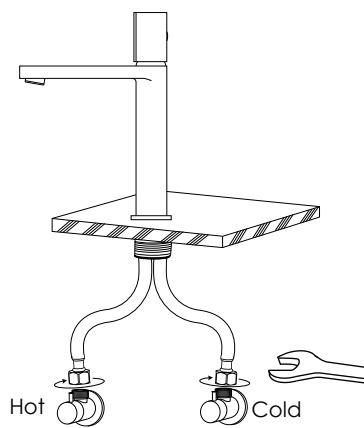

Connect hot and cold water lines to the inlet pipe and tighten with a wrench until snug. Do not over tight.

CARE AND CLEANING

Clean the faucet frequently using mild soap or an on-abrasive cleaner and then quickly rinse with water and dry with soft cloth only.

Using abrasive cleaners, solvents, acid cleaners or any scrubbing detergent, polisher or scraper will damage the finish and void the warranty.

AVANT DE COMMENCER VOTRE INSTALLATION



Coupez l'alimentation en eau



Videz les conduites d'eau chaude et froide



Outils nécessaires



Installation par un plombier professionnel accrédité



Videz la conduite d'eau avant l'installation



Les illustrations ne sont données qu'à titre indicatif



Ne pas démonter le boîtier

INSTALLATION DU ROBINET

1

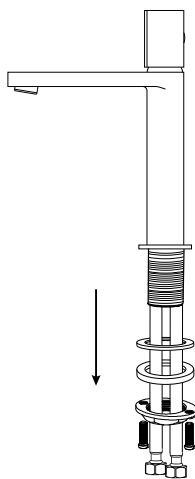

Retirez la rondelle et l'écrou de montage.

2

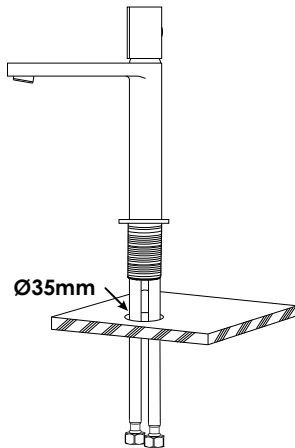

Assurez-vous d'avoir un trou traversant de Ø35mm sur le comptoir. Positionnez et insérez le robinet dans le trou du comptoir prévu à cet effet.

3

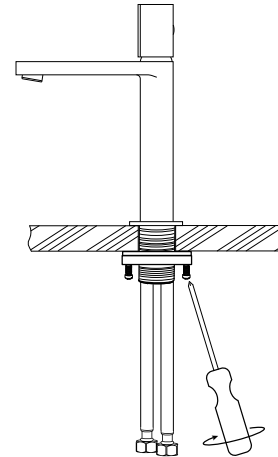

Serrez l'écrou de montage avec les vis jusqu'à ce que le robinet soit fermement fixé.

4

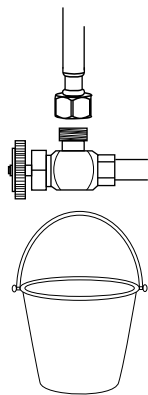

Avant de connecter le tuyau d'alimentation, rincez les vannes d'alimentation pour éliminer tout débris. Placez un seau sous les vannes et faites couler de l'eau pendant 5 à 10 secondes. Coupez l'eau.

5

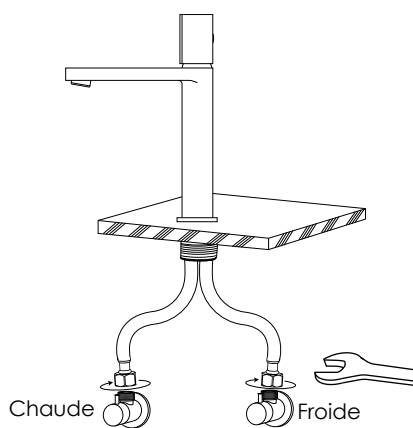

Raccordez les conduites d'eau chaude et froide au tuyau d'entrée et serrez-les fermement à l'aide d'une clé. Ne pas trop serrer.

ENTRETIEN ET NETTOYAGE

Nettoyez fréquemment le robinet à l'aide d'un savon doux ou d'un nettoyant non abrasif, puis rincez-le rapidement à l'eau et séchez-le avec un chiffon doux.

L'utilisation de nettoyants abrasifs, de solvants, de nettoyants acides ou de tout autre détergent à récurer, polisseur ou grattoir endommagera la finition et annulera la garantie.