



L100L & L150L

Losone Select Inline/Cabinet Ventilators



Incredibly reliable. Unbelievably quiet.
Offering the CFM choices you need at the lowest sound levels in the industry.

FEATURES:

Blower:

- Low RPM for quiet operation
- Resilient anti-vibration mounts
- Dynamically-balanced, polymeric, centrifugal blower wheel for quiet, efficient performance
- Permanently lubricated, thermally protected motor
- Plug-in motor rated at 120 VAC
- Designed for continuous operation

Housing:

- Rugged, 20 gauge galvanized steel
- 6" round duct connectors
- May be installed in ceiling or wall (size permitting)
- 8-position mounting brackets for easy installation and greater adaptability to various mounting requirements
- Automatic backdraft damper located within duct connector
- Factory-shipped in horizontal discharge position - easily converted to vertical discharge
- Removable panel allows easy access to the motor without disturbing ductwork
- Suitable for kitchen installations

TYPICAL SPECIFICATION:

Ventilator shall have galvanized steel housing. Housing to have adjustable mounting brackets and removable panel to allow access to motor without disturbing ductwork.

Automatic backdraft damper to be located within duct connector. Duct connector, blower assembly and wiring plate shall be adjustable for either horizontal or vertical installation.

Blower unit shall be removable from housing and will have a polymeric, dynamically balanced centrifugal-type blower wheel. Motor to be permanently lubricated and mounted with resilient anti-vibration mounts. RPM not to exceed number listed for each model.

Air delivery shall be no less and sound levels no greater than listed for each model. All air and sound ratings shall be certified by AMCA. Units to be cULus listed.



S&P USA Ventilation Systems, LLC, Div. of Soler & Palau Ventilation Group, certifies that the Losone Select Series shown herein are licensed to bear the AMCA Seal. The ratings shown are based on test and procedures performed in accordance with AMCA Publication 211 and AMCA Publication 311 and comply with the requirement of the AMCA Certified Ratings Program.



WEIGHT:

MODEL NO.	SHIPPING WEIGHT
L100L	22.9 lbs.
L150L	22.9 lbs.

DIMENSIONS:

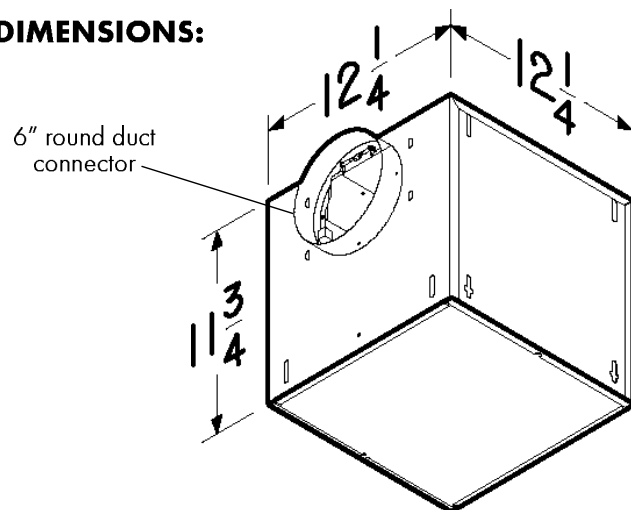



L100L & L150L

Losone Select Inline/Cabinet Ventilators



PERFORMANCE RATINGS:

AMCA LICENSED PERFORMANCE RATINGS

MODEL NO.	NOMINAL VOLTAGE	CFM/SONES - AT STATIC PRESSURES (Ps - inches of H ₂ O)											NOMINAL RPM	AMPS @ 60 Hz	WATTS
		0.0" Ps	.10" Ps	.125" Ps	.250" Ps	.375" Ps	.50" Ps	.625" Ps	.750" Ps	.875" Ps	1.0" Ps				
L100L	120 VAC	CFM St. Thr.	121	108	106	97	93	86	70	44	-	-	760	1.1	87
		Sones St. Thr.	0.5	0.7	0.7	1.1	1.4	1.8	2.1	2.4	-	-			
		CFM Rt. Ang.	109	98	96	88	82	78	67	48	16	-	780	1.1	87
		Sones Rt. Ang.	0.5	0.8	0.8	1.2	1.6	2.0	2.3	2.5	2.8	-			
L150L	120 VAC	CFM St. Thr.	153	148	147	140	134	125	111	91	54	-	920	1.3	100
		Sones St. Thr.	0.9	1.0	1.1	1.4	1.6	1.9	2.1	2.2	2.4	-			
		CFM Rt. Ang.	144	138	137	131	123	114	102	83	54	17	950	1.3	100
		Sones Rt. Ang.	1.2	1.4	1.4	1.6	1.9	2.1	2.4	2.5	2.7	2.9			

Performance ratings include the effects of backdraft damper in the airstream. Speed (RPM) shown is nominal. Performance is based on actual speed of test. The sound ratings shown are loudness values in fan sones at 5' (1.5m) in a hemispherical free field calculated per AMCA Std. 301. Values shown are for Installation Type D: Ducted inlet, Ducted outlet. Ratings do not include the effect of duct end correction. Performance ratings include the effects of 18 feet of round inlet duct and, if needed, a rectangular to round duct transition in the airstream. Performance shown is for Installation Type D: Ducted inlet, Ducted outlet.



S&P USA Ventilation Systems, LLC, Div. of Soler & Palau Ventilation Group, certifies that the Losone Select Series shown herein are licensed to bear the AMCA Seal. The ratings shown are based on test and procedures performed in accordance with AMCA Publication 211 and AMCA Publication 311 and comply with the requirement of the AMCA Certified Ratings Program.

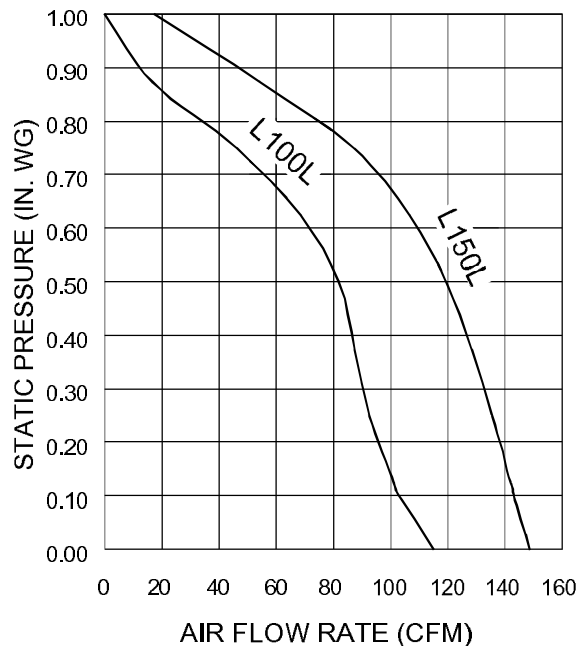

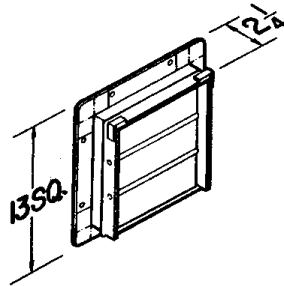

Model 441 Wall Cap

- Gravity dampers
- Collar with birdscreen for attaching 10" round duct
- Steel construction with aluminum louvers

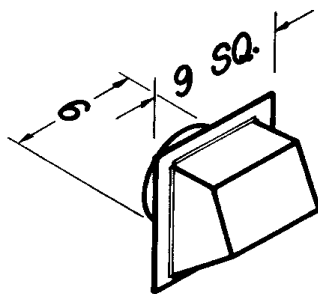

Model 641 Wall Cap

- Aluminum natural finish
- Built-in backdraft damper & birdscreen
- For 6" round duct

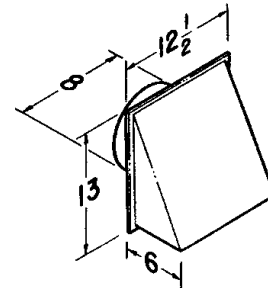

Model 643 Wall Cap

- Aluminum natural finish
- Built-in backdraft damper
- For 8" round duct

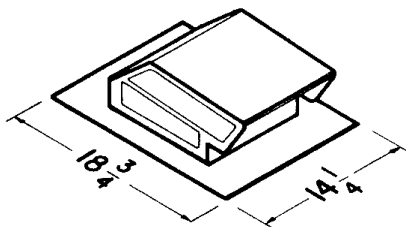

Model 634 Roof Cap

- Black electrically - bonded epoxy finish
- Built-in backdraft damper & birdscreen
- For 3 1/4" x 10" or up to 8" round duct

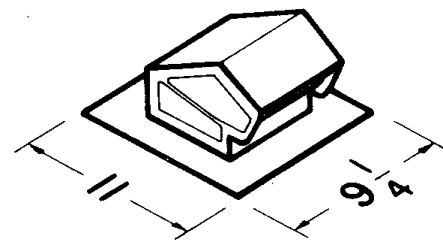

Model 636 Roof Cap

- Black electrically - bonded epoxy finish
- Built-in backdraft damper & birdscreen
- For 3" or 4" round duct

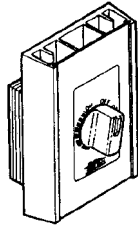

Speed Control

- Adjust speed from 100 to 50%
- 5 amp & 10 amp - 120V

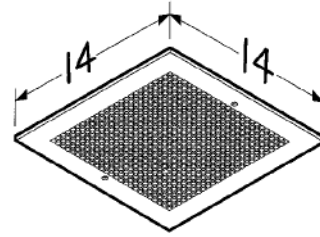

Model MG 1 Metal Grille Kit

- White enamel painted steel
- Mounting screws included
- Fits L100, L150, L200, L250 & L300

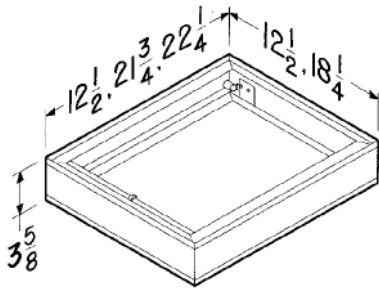

Models RD1, RD2 & RD3 Radiation Dampers

- UL rated for use in 1, 2 or 3 hour rated floor-ceiling, roof-ceiling design
- Galvanized steel frame
- High temperature, non-asbestos, reinforced fiberthermal fabric
- 212 °F fusible link
- Stainless steel negator-type closure spring
- RD1 (12 1/2" X 12 1/2") fits L100 - L300
- RD2 (21 3/4" X 12 1/2") fits L400 - L700
- RD3 (22.25" X 18.25") fits L900 - L1500

OPTIONAL ACCESSORY COMPATIBILITY CHART		LOSONE SELECT CEILING MOUNT						LOSONE SELECT IN-LINE/CABINET					
		L100 L150	L200 L250 L300	L400 L500	L700	L900	L1500	L100L L150L	L200L L250L L300L	L400L L500L L700L	L900L	L1500L	L2000L
VARIABLE SPEED CONTROLS	2727.1 (5 AMP 120V) ●	X	X	X			X	X					
	2828.1 (10AMP 120V) ●	X	X	X	X	X	X	X	X	X	X	X	X
Roof Caps	634 ●	X	X					X	X				
	636 ●												
WALL CAPS	441 ◆			X	X					X			
	641 ●	X						X					
	643 ●		X						X				
UL RADIATION DAMPERS	RD1 ◆	X	X										
	RD2 ◆			X	X								
	RD3 ◆					X	X						
METAL GRILLE KIT	MG1 ●	X	X										
VIBRATION DAMPENING HANGERS (4)	V102 ●	X	X	X	X	X		X	X	X	X		
	V104KIT ●	X	X	X	X	X	X	X	X	X	X	X	X



Incredibly reliable. Unbelievably quiet.
Offering the CFM choices you need at the lowest sound levels in the industry.

FEATURES:

Blower:

- Low RPM for quiet operation
- Resilient anti-vibration mounts
- Dynamically-balanced, polymeric, centrifugal blower wheel for quiet, efficient performance
- Permanently lubricated, thermally protected motor
- Plug-in motor rated at 120 VAC
- Designed for continuous operation

Housing:

- Rugged, galvanized steel
- 8" round duct connectors
- May be installed in ceiling or wall (size permitting)
- 8-position mounting brackets for easy installation and greater adaptability to various mounting requirements
- Automatic backdraft damper located within duct connector
- Factory-shipped in horizontal discharge position - easily converted to vertical discharge
- Removable panel allows easy access to the motor without disturbing ductwork
- Suitable for kitchen installations

TYPICAL SPECIFICATION:

Ventilator shall have galvanized steel housing. Housing to have adjustable mounting brackets and removable panel to allow access to motor without disturbing ductwork.

Automatic backdraft damper to be located within duct connector. Duct connector, blower assembly and wiring plate shall be adjustable for either horizontal or vertical installation.

Blower unit shall be removable from housing and will have a polymeric, dynamically balanced centrifugal-type blower wheel. Motor to be permanently lubricated and mounted with resilient anti-vibration mounts. RPM not to exceed number listed for each model.

Air delivery shall be no less and sound levels no greater than listed for each model. All air and sound ratings shall be certified by AMCA. Units to be cULus listed.



S&P USA Ventilation Systems, LLC, Div. of Soler & Palau Ventilation Group, certifies that the Losone Select Series shown herein are licensed to bear the AMCA Seal. The ratings shown are based on test and procedures performed in accordance with AMCA Publication 211 and AMCA Publication 311 and comply with the requirement of the AMCA Certified Ratings Program.



WEIGHT:

MODEL NO.	SHIPPING WEIGHT
L200L	23.1 lbs.
L250L	23.2 lbs.
L300L	23.2 lbs.

DIMENSIONS:

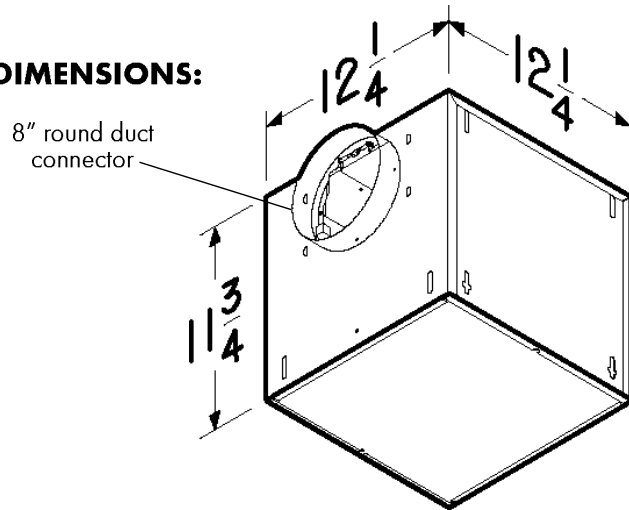



PERFORMANCE RATINGS:

AMCA LICENSED PERFORMANCE RATINGS

MODEL NO.	NOMINAL VOLTAGE	CFM/SONES - AT STATIC PRESSURES (Ps - inches of H ₂ O)											NOMINAL RPM	AMPS @ 60 Hz	WATTS
			0.0" Ps	.10" Ps	.125" Ps	.250" Ps	.375" Ps	.50" Ps	.625" Ps	.750" Ps	.875" Ps	1.0" Ps			
L200L	120 VAC	CFM St. Thr.	205	196	195	190	185	175	158	135	96	47	865	1.8	127
		Sones St. Thr.	1.7	1.9	1.9	2.1	2.3	2.4	3.0	3.3	3.4	3.4			
		CFM Rt. Ang.	183	177	176	170	163	152	137	121	96	51	930	1.8	127
		Sones Rt. Ang.	1.6	1.6	1.6	1.9	2.3	2.7	2.9	3.1	3.4	3.6			
L250L	120 VAC	CFM St. Thr.	248	245	245	241	235	224	208	183	141	84	1005	2.1	166
		Sones St. Thr.	2.0	2.3	2.3	2.6	2.8	3.2	3.4	3.6	3.9	3.8			
		CFM Rt. Ang.	229	224	222	214	204	193	177	157	132	95	1115	2.1	166
		Sones Rt. Ang.	2.4	2.5	2.6	2.8	3.0	3.2	3.4	3.7	3.8	3.8			
L300L	120 VAC	CFM St. Thr.	300	294	293	285	274	259	243	214	168	113	1145	2.6	212
		Sones St. Thr.	2.9	3.0	3.1	3.3	3.4	3.5	3.6	3.7	4.0	3.9			
		CFM Rt. Ang.	270	261	259	248	234	220	200	174	146	104	1285	2.6	212
		Sones Rt. Ang.	3.7	3.7	3.7	3.7	3.9	3.9	4.0	4.2	4.4	4.0			

Performance ratings include the effects of backdraft damper in the airstream. Speed (RPM) shown is nominal. Performance is based on actual speed of test.

The sound ratings shown are loudness values in fan sones at 5' (1.5m) in a hemispherical free field calculated per AMCA Std. 301. Values shown are for Installation Type D: Ducted inlet, Ducted outlet. Ratings do not include the effect of duct end correction. Performance ratings include the effects of 18 feet of round inlet duct and, if needed, a rectangular to round duct transition in the airstream. Performance shown is for Installation Type D: Ducted inlet, Ducted outlet.

AMCA WORLDWIDE CERTIFIED RATINGS
SOUND AND AIR PERFORMANCE
S&P USA Ventilation Systems, LLC, Div. of Soler & Palau Ventilation Group, certifies that the Losone Select Series shown herein are licensed to bear the AMCA Seal. The ratings shown are based on test and procedures performed in accordance with AMCA Publication 211 and AMCA Publication 311 and comply with the requirement of the AMCA Certified Ratings Program.

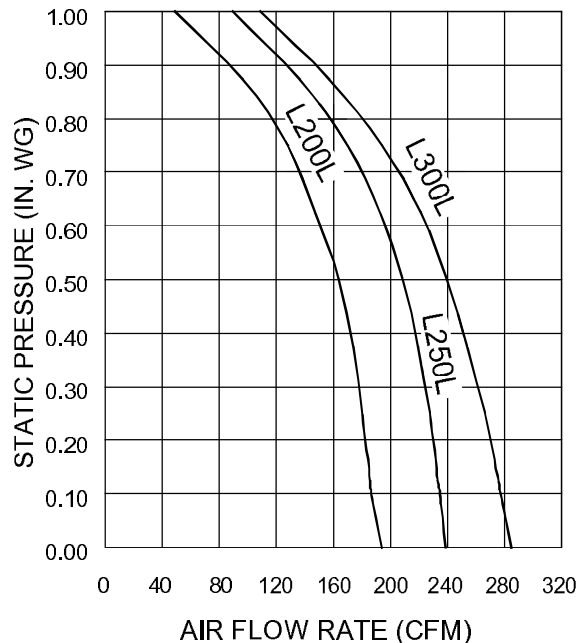

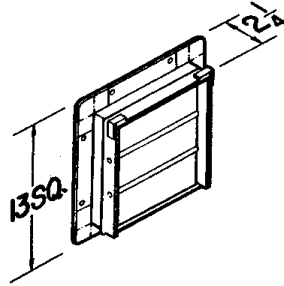

Model 441 Wall Cap

- Gravity dampers
- Collar with birdscreen for attaching 10" round duct
- Steel construction with aluminum louvers

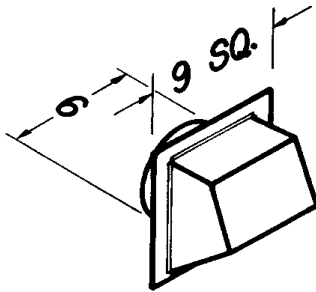

Model 641 Wall Cap

- Aluminum natural finish
- Built-in backdraft damper & birdscreen
- For 6" round duct

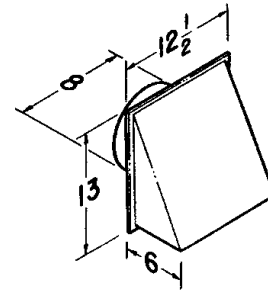

Model 643 Wall Cap

- Aluminum natural finish
- Built-in backdraft damper
- For 8" round duct

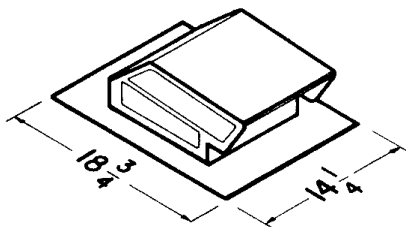

Model 634 Roof Cap

- Black electrically - bonded epoxy finish
- Built-in backdraft damper & birdscreen
- For 3 1/4" x 10" or up to 8" round duct

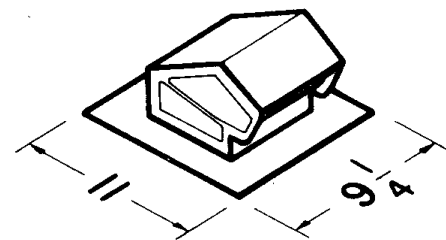

Model 636 Roof Cap

- Black electrically - bonded epoxy finish
- Built-in backdraft damper & birdscreen
- For 3" or 4" round duct

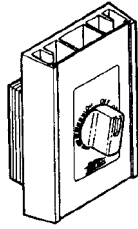

Speed Control

- Adjust speed from 100 to 50%
- 5 amp & 10 amp - 120V

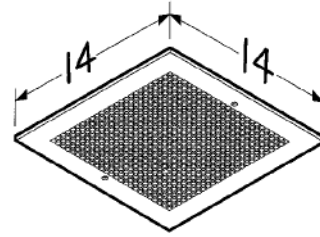

Model MG 1 Metal Grille Kit

- White enamel painted steel
- Mounting screws included
- Fits L100, L150, L200, L250 & L300

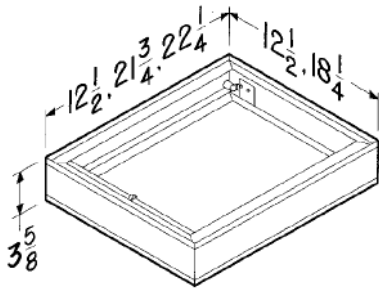

Models RD1, RD2 & RD3 Radiation Dampers

- UL rated for use in 1, 2 or 3 hour rated floor-ceiling, roof-ceiling design
- Galvanized steel frame
- High temperature, non-asbestos, reinforced fiberthermal fabric
- 212 °F fusible link
- Stainless steel negator-type closure spring
- RD1 (12 1/2" X 12 1/2") fits L100 - L300
- RD2 (21 3/4" X 12 1/2") fits L400 - L700
- RD3 (22.25" X 18.25") fits L900 - L1500

OPTIONAL ACCESSORY COMPATIBILITY CHART		LOSONE SELECT CEILING MOUNT						LOSONE SELECT IN-LINE/CABINET					
		L100 L150	L200 L250 L300	L400 L500	L700	L900	L1500	L100L L150L	L200L L250L L300L	L400L L500L L700L	L900L	L1500L	L2000L
VARIABLE SPEED CONTROLS	2727.1 (5 AMP 120V) ●	X	X	X			X	X					
	2828.1 (10AMP 120V) ●	X	X	X	X	X	X	X	X	X	X	X	X
Roof Caps	634 ●	X	X					X	X				
	636 ●												
WALL CAPS	441 ◆			X	X					X			
	641 ●	X						X					
	643 ●		X						X				
UL RADIATION DAMPERS	RD1 ◆	X	X										
	RD2 ◆			X	X								
	RD3 ◆					X	X						
METAL GRILLE KIT	MG1 ●	X	X										
VIBRATION DAMPENING HANGERS (4)	V102 ●	X	X	X	X	X		X	X	X	X		
	V104KIT ●	X	X	X	X	X	X	X	X	X	X	X	X