



L400, L500 & L700

Losone Select Ceiling Mount Ventilators

Incredibly reliable. Unbelievably quiet.
Offering the CFM choices you need at the lowest sound levels in the industry.

FEATURES:

Grill:

- Conceals interior
- Low profile styling blends with any decor
- Metal, finished with white painted enamel

Blower:

- Low RPM for quiet operation
- Resilient anti-vibration mounts
- Balanced, polymeric, centrifugal blower wheel for quiet, efficient performance
- Permanently lubricated, thermally protected motor
- Plug-in motor rated at 120 VAC
- Designed for continuous operation

Housing:

- Rugged, 20 gauge galvanized steel
- 4½" x 18½" duct connector
- 1/2" acoustic insulation inside
- May be installed in ceiling or wall (size permitting)
- 8-position mounting brackets for easy installation and greater adaptability to various mounting requirements
- Automatic backdraft damper located within duct connector
- Factory-shipped in horizontal discharge position - easily converted to vertical discharge

TYPICAL SPECIFICATION:

Ventilator shall have galvanized steel housing insulated with at least 1/2" of acoustic insulation. Housing to have adjustable mounting brackets.

Automatic backdraft damper to be located within duct connector. Duct connector, blower assembly and wiring plate shall be adjustable for either horizontal or vertical installation.

Blower unit shall be removable from housing and will have a polymeric, dynamically balanced centrifugal-type blower wheel. Motor to be permanently lubricated and mounted with resilient anti-vibration mounts. RPM not to exceed number listed for each model.

Air delivery shall be no less and sound levels no greater than listed for each model. All air and sound ratings shall be certified by AMCA. Units to be cULus listed.

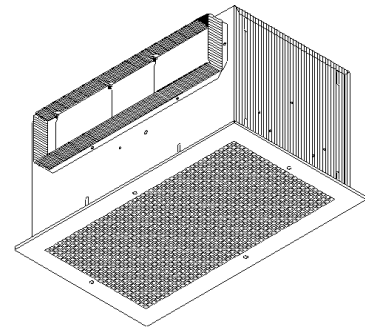

S&P USA Ventilation Systems, LLC, Div. of Soler & Palau Ventilation Group, certifies that the Losone Select Series shown herein are licensed to bear the AMCA Seal. The ratings shown are based on test and procedures performed in accordance with AMCA Publication 211 and AMCA Publication 311 and comply with the requirement of the AMCA Certified Ratings Program.



cULus listed for use over bathtubs and showers when connected to a GFCI protected branch circuit.

WEIGHT:

MODEL NO.	SHIPPING WEIGHT
L400	33.8 lbs.
L500	33.8 lbs.
L700	33.9 lbs.

DIMENSIONS:

4½" x 18½"
duct connector

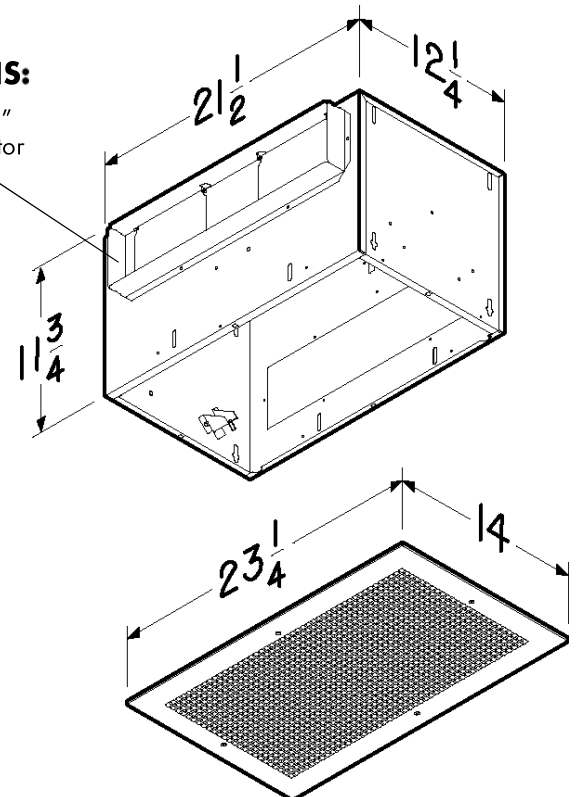

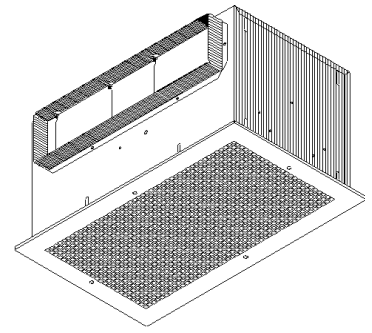

PERFORMANCE RATINGS:

AMCA LICENSED PERFORMANCE RATINGS

MODEL NO.	NOMINAL VOLTAGE	CFM/SONES - AT STATIC PRESSURES (Ps - inches of H ₂ O)											NOMINAL RPM	AMPS @ 60 Hz	WATTS
		0.0" Ps	.10" Ps	.125" Ps	.250" Ps	.375" Ps	.50" Ps	.625" Ps	.750" Ps	.875" Ps	1.0" Ps				
L400	120 VAC	CFM Hor.	480	442	434	388	344	299	229	182	114	-	735	1.4	146
		Sones Hor.	2.0	2.4	2.3	2.8	3.3	3.8	4.5	4.8	5.4	-			
		CFM Ver.	467	428	416	378	335	291	237	170	85	8	755	1.4	146
		Sones Ver.	2.3	2.6	2.6	3.0	3.5	4.0	5.1	5.5	5.7	5.9			
L500	120 VAC	CFM Hor.	538	520	514	491	463	434	389	339	282	186	810	2.2	232
		Sones Hor.	3.0	3.1	3.3	3.6	4.0	4.4	5.0	5.7	6.2	6.7			
		CFM Ver.	539	517	512	481	451	418	367	319	247	137	865	2.2	232
		Sones Ver.	2.9	3.1	3.2	3.4	3.8	4.2	4.8	5.9	6.3	6.4			
L700	120 VAC	CFM Hor.	722	704	701	667	640	607	571	534	453	333	960	2.9	313
		Sones Hor.	4.5	4.6	4.7	4.8	5.0	5.2	5.6	6.2	7.1	7.2			
		CFM Ver.	708	691	687	658	628	597	560	515	444	312	985	2.9	313
		Sones Ver.	5.2	5.0	5.0	5.7	5.8	6.1	6.4	7.4	7.1	7.6			

Performance ratings include the effects of inlet grill and backdraft damper in the airstream. Speed (RPM) shown is nominal. Performance is based on actual speed of test. The sound ratings shown are loudness values in fan sones at 5' (1.5m) in a hemispherical free field calculated per AMCA Std. 301. Values shown are for Installation Type B: free inlet fan sone levels. Performance shown is for Installation Type B: Free inlet, Ducted outlet.

AMCA WORLDWIDE CERTIFIED RATINGS
SOUND and **AIR** PERFORMANCE
S&P USA Ventilation Systems, LLC., Div. of Soler & Palau Ventilation Group, certifies that the Losone Select Series shown herein are licensed to bear the AMCA Seal. The ratings shown are based on test and procedures performed in accordance with AMCA Publication 211 and AMCA Publication 311 and comply with the requirement of the AMCA Certified Ratings Program.

UL LISTED
cULus listed for use over bathtubs and showers when connected to a GFCI protected branch circuit.

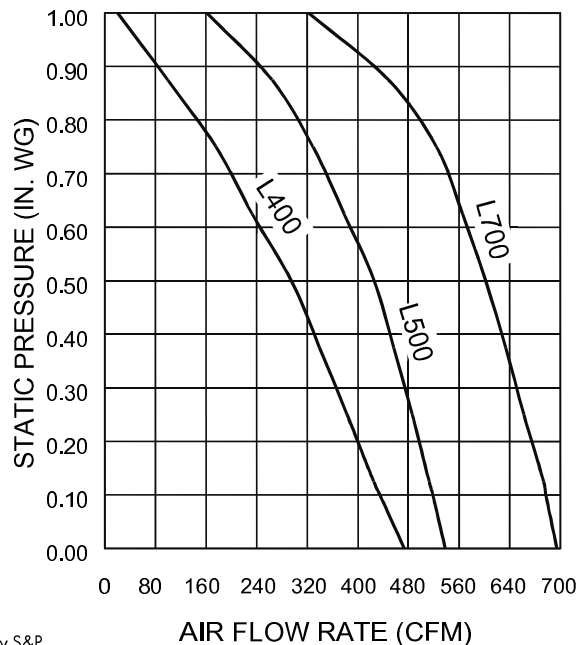

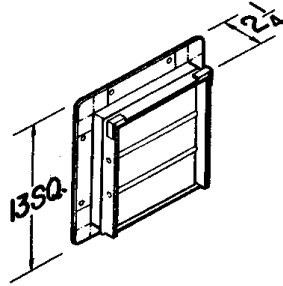

Model 441 Wall Cap

- Gravity dampers
- Collar with birdscreen for attaching 10" round duct
- Steel construction with aluminum louvers

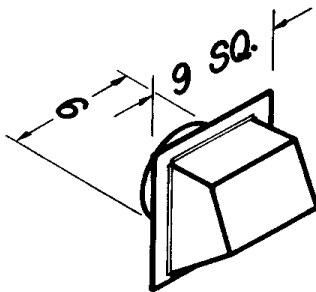

Model 641 Wall Cap

- Aluminum natural finish
- Built-in backdraft damper & birdscreen
- For 6" round duct

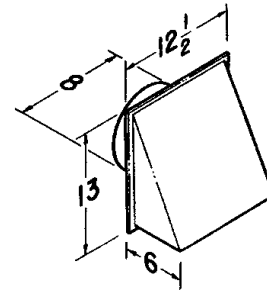

Model 643 Wall Cap

- Aluminum natural finish
- Built-in backdraft damper
- For 8" round duct

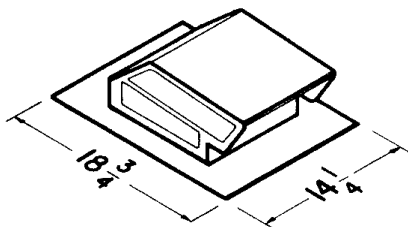

Model 634 Roof Cap

- Black electrically - bonded epoxy finish
- Built-in backdraft damper & birdscreen
- For 3 1/4" x 10" or up to 8" round duct

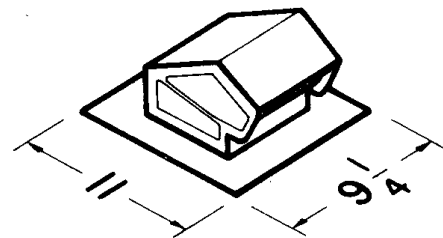

Model 636 Roof Cap

- Black electrically - bonded epoxy finish
- Built-in backdraft damper & birdscreen
- For 3" or 4" round duct

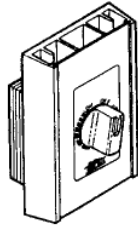

Speed Control

- Adjust speed from 100 to 50%
- 5 amp & 10 amp - 120V

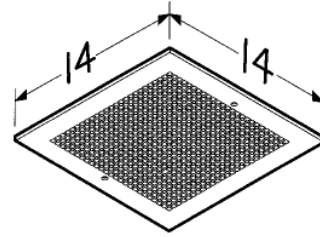

Model MG 1 Metal Grille Kit

- White enamel painted steel
- Mounting screws included
- Fits L100, L150, L200, L250 & L300

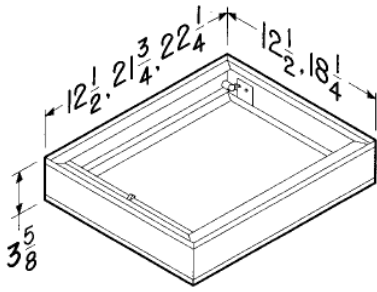

Models RD1, RD2 & RD3 Radiation Dampers

- UL rated for use in 1, 2 or 3 hour rated floor-ceiling, roof-ceiling design
- Galvanized steel frame
- High temperature, non-asbestos, reinforced fiberthermal fabric
- 212 °F fusible link
- Stainless steel negator-type closure spring
- RD1 (12 1/2" X 12 1/2") fits L100 - L300
- RD2 (21 3/4" X 12 1/2") fits L400 - L700
- RD3 (22.25" X 18.25") fits L900 - L1500

OPTIONAL ACCESSORY COMPATIBILITY CHART		LOSONE SELECT CEILING MOUNT						LOSONE SELECT IN-LINE/CABINET					
		L100 L150	L200 L250 L300	L400 L500	L700	L900	L1500	L100L L150L	L200L L250L L300L	L400L L500L L700L	L900L	L1500L	L2000L
VARIABLE SPEED CONTROLS	2727.1 (5 AMP 120V) ●	X	X	X			X	X					
	2828.1 (10AMP 120V) ●	X	X	X	X	X	X	X	X	X	X	X	X
Roof Caps	634 ●	X	X					X	X				
	636 ●												
WALL CAPS	441 ◆			X	X					X			
	641 ●	X						X					
	643 ●		X						X				
UL RADIATION DAMPERS	RD1 ◆	X	X										
	RD2 ◆			X	X								
	RD3 ◆					X	X						
METAL GRILLE KIT	MG1 ●	X	X										
VIBRATION DAMPENING HANGERS (4)	V102 ●	X	X	X	X	X		X	X	X	X		
	V104KIT ●	X	X	X	X	X	X	X	X	X	X	X	X